



# FASANO

TOOLS

## PROMODAY

# 2024

ITALIA € IVA ESCLUSA



	<b>CHIAVI DI MANOVRA</b>	<b>8</b>
	<b>CHIAVI A BUSSOLA</b>	<b>12</b>
	<b>GIRAVITI E PINZE</b>	<b>20</b>
	<b>ELETTRONICA E ELETTROTECNICA</b>	<b>24</b>
	<b>UTENSILI DINAMOMETRICI</b>	<b>26</b>
	<b>UTENSILI DA TAGLIO</b>	<b>28</b>
	<b>MANUTENZIONE GENERALE</b>	<b>30</b>
	<b>LAMPADE</b>	<b>34</b>
	<b>BORSE DA LAVORO</b>	<b>42</b>
	<b>ESTRATTORI</b>	<b>48</b>
	<b>UTENSILI PNEUMATICI</b>	<b>50</b>
	<b>CARRELLI E BANCHI DA LAVORO</b>	<b>58</b>
	<b>ARREDAMENTO TECNICO</b>	<b>98</b>
	<b>ARREDAMENTO FURGONI</b>	<b>106</b>
	<b>AUTOMOTIVE</b>	<b>110</b>
	<b>PROFESSIONAL EQUIPMENT</b>	<b>130</b>

# L'azienda

## Realizziamo strumenti professionali dal 1976

Nata nel 1976, l'azienda lancia nel 2002 il marchio **FASANO TOOLS** che, sin da subito, si pone sul mercato come un brand innovativo ed alternativo nel mondo dell'utensileria professionale. **Oltre 40 anni** di esperienza e l'ascolto continuo di fruitori e partner commerciali, hanno consentito all'impresa di crescere e diventare una realtà di riferimento nel settore, consolidare la sua presenza a livello Nazionale e rafforzare quella a livello Internazionale.

# NUOVA

# SEDE PRODUTTIVA

L'ampliamento della gamma di prodotti degli ultimi anni, corrisponde ad un ampliamento strutturale della sede operativa Fasano Tools.

## PIÙ SPAZIO PER NUOVI PROGETTI

Con una superficie di oltre 1000 mq, il nuovo stabilimento Fasano Tools, realizzato nel 2023, oggi ospita diverse attività a pieno regime quali il taglio e la punzonatura, la piegatura automatica, la saldatura e l'assemblaggio di tutti i prodotti lamierati presenti a catalogo.



I nostri tecnici specializzati, al suo interno, lavorano, grazie all'ausilio di macchinari innovativi ad alta vocazione tecnologica, alla produzione di lamierati per la messa in opera di carrelli porta utensili, armadi, cassettiere ed ogni altro modulo e struttura di arredo tecnico industriale.

Il nuovo stabilimento, per ora a pieno regime su queste attività specifiche, nel corso del 2024 sarà destinato anche allo studio ed alla realizzazione di nuovi progetti, già in cantiere.





Fasano Tools si differenzia sul mercato per l'**ampia gamma di attrezzi** da lavoro che copre tutti i settori di riferimento e per la vasta e costante disponibilità dei ricambi. Punti di forza della nostra realtà sono, infatti, l'assistenza e l'attenzione alle certificazioni, volontarie e obbligatorie, alle quali sono sottoposti puntualmente i prodotti, per rispettare, come da norme vigenti, gli standard internazionali.

Supporto fondamentale per l'attività di **Fasano Tools è il sito web**, straordinariamente ricco di informazioni sui prodotti, schede tecniche dettagliate, manuali, elenco ricambi e strumenti innovativi per trovare l'attrezzo o il kit necessario al proprio lavoro. Come il Tool Finder, rivoluzionario motore di ricerca interno, dedicato alla gamma dei prodotti per fasatura motore.

La comunicazione di Fasano Tools si estende, inoltre, dal web al mondo dei Social media, dove si caratterizza per un'attività mirata e differente per ogni Canale.



Con oltre 40 anni di esperienza, l'azienda ha una **VISION** ben chiara.

Si propone di non perdere mai quello spirito critico verso il mondo e il mercato e, attraverso l'impegno costante e la ricerca di innovazioni a supporto del lavoro, di affrontare con flessibilità le sfide del settore e di anticiparne le evoluzioni. **Oggi come ieri.**

# NUOVE BORSE PORTA UTENSILI

**CAPIENTI, COMODE E SUPER FUNZIONALI. CON LE NUOVE BORSE PORTA UTENSILI FASANO TOOLS PORTI IL TUO LAVORO OVUNQUE E TUTTO QUELLO CHE TI SERVE È SEMPRE CON TE!**

**6 NUOVI MODELLI** per ogni esigenza lavorativa. **Ampi scomparti separati e tasche multiple, laterali e frontali**, per riporre i tuoi utensili, differenziandone l'utilizzo e riprendere poi ciò che ti serve, senza perdere tempo. Non solo attrezzi! I nostri modelli di borse porta utensili sono ideati per trasportare anche oggetti di uso quotidiano come pc, chiavi, smartphone e tutto il necessario per lavorare fuori dagli ambienti di lavoro.



**NEW**



## TROLLEY, TRACOLLE, CESTELLI, BORSONI E ZAINI

Scegli lo **zaino con gli spallacci** imbottiti per avere le mani libere e conservare documenti e pc portatile. Con lo **zaino provvisto di manico telescopico** e ruote invece, puoi viaggiare anche in aereo e fare lunghi tragitti a piedi, senza fatica.

Prediligi un **cestello con copertura**, se preferisci il connubio tra la classica cassetta porta attrezzi ed un borsoni provvisto di tracolla.

Due **borsoni** con ampi scomparti interni e tasche esterne, ti permettono di separare gli oggetti di uso quotidiano dagli utensili da lavoro.

Puoi scegliere tra una struttura completamente rigida o una semi rigida.

Infine, con il **trolley**, trasporti con facilità utensili elettrici o manuali di peso maggiore, dove vuoi, senza sforzi.

Tutte realizzate in tessuto tecnico, le Borse Porta Utensili Fasano Tools sono la tua soluzione versatile ad ogni esigenza giornaliera. E che stile!





**TSC  
SYSTEM**

**TECNOLOGIA DI  
SPEGNIMENTO  
PER CONTATTO**



## AMPIA GAMMA DI LAMPADE A LED



## FUNZIONI INNOVATIVE

**CHE RENDONO SEMPLICI  
LE OPERAZIONI PIÙ COMPLICATE.**



IK07



**RISPARMIO  
ENERGETICO**



**MASSIMA  
AUTONOMIA**



**FUNZIONE  
POWER BANK**



**TSC  
SYSTEM**



**CASSE  
WIRELESS**



**GRADO  
DI PROTEZIONE  
IP65**



CASSE WIRELESS



GRADO  
DI RESISTENZA  
AGLI URTI IK 07



# CARICABATTERIE



TROVA LA GIUSTA CARICA PER IL TUO LAVORO!

**NEW**

Con i nuovi **CARICABATTERIE FASANO TOOLS**,  
l'energia a disposizione non finisce mai.

**IDEALI PER MOTO,  
AUTO, MA ANCHE  
FURGONI,  
IMBARCAZIONI  
E MEZZI PESANTI.**



I nostri **CARICABATTERIE** presentano alcune  
funzioni davvero eccezionali che assicurano  
**UN ALTO GRADO DI EFFICIENZA ENERGETICA.**

**JUMP  
MODE**

**WINTER  
MODE**





**BE STRONG.  
BE POWERFUL.  
BE BRAVE.  
BI COLOR**

**L'ICONICO CARRELLO  
FG 100 FASANO TOOLS  
DIVENTA ANCHE  
BI COLOR!**

4 RUOTE IN GOMMA VULCANIZZATA  
CON DIAMETRO 125 MM  
(2 FISSE, 2 GIREVOLI)  
**VERSATILITA'**

7 CASSETTI CAPIENTI,  
TOTALMENTE APRIBILI E CORREDATI  
DI TAPPETINO INTERNO ANTIGRAFFIO  
**CAPIENZA**

Scegli tra le  
**14 VARIANTI**  
disponibili,  
il match che  
ti rappresenta  
di più!

CHIUSURA LATERALE  
CENTRALIZZATA  
**SICUREZZA**

PANNELLI LATERALI  
CON FORI PER GANCI PORTA UTENSILI  
E PORTA FLACONI DI SERIE  
**COMODITA'**

TOP IN ABS  
CON MANIGLIONE INTEGRATO  
**PRATICITA'**

**L'ENERGIA  
DEI NOSTRI  
NUOVI  
FG 100  
BI COLOR**



**IL MEGLIO DEL  
MADE IN ITALY**

I nostri carrelli sono frutto di un intenso lavoro di ricerca, sviluppo, progettazione e produzione interna.



## FG 600L/SC10

**SET CHIAVI COMBinate  
POLIGONALI EXTRA LUNGHE**

**CONTENUTO:**  
10, 11, 12, 13, 14, 15, 16, 17, 18, 19mm

~~155,00€~~ **89,00€**



## FG 600/SC17

**SET 17 CHIAVI COMBinate  
POLIGONALI IN BOX DI CARTONE**

**CONTENUTO:**  
6, 7, 8, 9, 10, 11, 12, 13, 14,  
15, 16, 17, 18, 19, 20, 21, 22 mm

~~182,00€~~ **99,00€**



## FG 600/SC16

**SET 16 CHIAVI  
COMBinate POLIGONALI**

**CONTENUTO:**  
6,7,8,10,12,13,14,16,  
17,19,21,22,24,27,30,32 mm

~~232,00€~~ **139,00€**



## FG 600/SC25

**SET 25 CHIAVI COMBinate  
POLIGONALI IN BOX DI CARTONE**

**CONTENUTO:**  
6, 7, 8, 9, 10, 11, 12, 13, 14, 15, 16,  
17,18, 19, 20, 21, 22, 23, 24, 25, 26, 27,  
28, 30,32 mm

~~390,00€~~ **209,00€**



## FG 615/SC8

**SET CHIAVI POLIGONALI  
DOPPIE CURVE**

**CONTENUTO:**  
6x7, 8x9, 10x11, 12x13, 14x15, 16x17,  
18x19, 20x22mm

~~113,00€~~ **69,00€**



## FG 602/SC13

**SET 13 CHIAVI A DOPPIA  
FORCHETTA IN BOX DI CARTONE**

**CONTENUTO:**  
6x7, 8x9, 10x11, 12x13, 14x15, 16x17,  
18x19, 20x22, 21x23,  
24x26, 25x28, 27x29, 30x32 mm

~~145,00€~~ **89,00€**



**FG 614B/S13**

~~185,00€~~ **99,00€**

**SET CHIAVI A TUBO MOD. LEGGERO**

**CONTENUTO:**

6x7, 8x9, 10x11, 12x13, 14x15, 16x17, 18x19, 20x22,  
21x23, 24x26, 25x28, 27x29, 30x32mm



**FG 180/SP6**

~~125,00€~~ **72,50€**

**SET 6 CHIAVI PER RACCORDI TUBO IN ROTOLO DI NYLON**

**CONTENUTO:** 8x10, 10x11, 11x13, 12x14, 17x19, 19x22mm

**FG 180/SP9**

~~216,00€~~ **125,00€**

**SET 9 CHIAVI PER RACCORDI TUBO IN ROTOLO DI NYLON**

**CONTENUTO:** 8x10, 9x11, 10x11, 11x13, 12x14, 17x19, 19x22, 24x27, 30x32mm



**FG 616A/S6**

**SET 6 CHIAVI A T ESAGONALI SEMPLICI**

**CONTENUTO:** 8, 10, 12, 13, 14, 17mm

~~135,00€~~ **79,00€**



**FG 618E/S9**

**SET 9 CHIAVI A T SNODATE TORX IN BOX DI CARTONE**

**CONTENUTO:** E6, E7, E8, E10, E12, E14, E16, E18, E20

~~439,00€~~ **249,00€**



**FG 618/S7B**

**SET 7 CHIAVI A T SNODATE ESAGONALI**

**CONTENUTO:**  
7, 8, 10, 12, 13, 14, 17mm

~~257,50€~~ **155,00€**



**FG 618/S7**

**SET 7 CHIAVI A T SNODATE ESAGONALI**

**CONTENUTO:**  
8, 10, 11, 13, 14, 17, 19 mm

~~278,50€~~ **169,00€**



**FG 618/S10**

**SET 10 CHIAVI A T SNODATE ESAGONALI**

**CONTENUTO:**  
8, 10, 11, 12, 13, 14,  
15, 16, 17, 19 mm

~~404,50€~~ **239,00€**



ASTA SCORREVOLE



**FG 621H/S8C**

SET 8 CHIAVI A T MASCHIO ESAGONALI CON ASTA SCORREVOLE

~~152,00€~~ **89,00€**

CONTENUTO: 2,2.5,3,4,5,6,8,10mm

ASTA SCORREVOLE



**FG 621TX/S13**

SET 13 CHIAVI A T MASCHIO TORX CON ASTA SCORREVOLE

~~235,00€~~ **129,00€**

CONTENUTO: 6,7,8,9,10,15, 20,25,27,30,40, 45,50 TX

CHIAVE POLIGONALE DOPPIA



**FG 609A/S5**

~~102,00€~~ **59,00€**

SET 5 CHIAVI DOPPIE POLIGONALI

CONTENUTO: 10x12, 11x13, 14x17, 16x18, 19x22 mm

CHIAVE DOPPIA DIRITTA TORX



**FG 600E/S4**

~~53,56€~~ **32,00€**

SET 4 CHIAVI DOPPIE DIRITTE TORX

CONTENUTO: E6xE8, E10xE12, E14xE18, E20xE24

**FG 617A/S7**

SET 7 CHIAVI A TESTA FLESSIBILE CON CRICCO UNIVERSALE

CONTENUTO: 8, 10, 12, 13, 14, 15, 17mm

~~165,00€~~ **75,00€**



**FG 615A/S6**

SET 6 CHIAVI DOPPIE CON CRICCO REVERSIBILE UNIVERSALE A 90 DENTI

CONTENUTO: 8x9, 10x11, 12x13, 14x15, 16x18, 17x19mm

~~130,00€~~ **75,00€**

**FG 622A/S2**

SET 2 CHIAVI A CRICCO UNIVERSALE SERIE EXTRA-LUNGA

CONTENUTO: 21x22, 24x27 mm

~~80,00€~~ **49,00€**





**FG 606/SP9**

~~132,00€~~ **79,00€**

**SET 9 CHIAVI COMBinate NON REVERSIBILI IN ROTOLO DI NYLON**

CONTENUTO: 8,10,11,12,13,14,15,17,19 mm



**FG 610FL/SP9**

~~236,00€~~ **135,00€**

**SET 9 CHIAVI COMBinate A CRICCO FLESSIBILI IN ROTOLO DI NYLON**

CONTENUTO: 8, 10, 12, 13, 15, 16, 17, 18, 19 mm



**FG 605/SP6**

~~110,00€~~ **65,00€**

**SET 6 CHIAVI COMBinate REVERSIBILI IN ROTOLO DI NYLON**

CONTENUTO:  
8,10,13,14,17,19 mm



**FG 605/SC15**

~~258,00€~~ **149,00€**

**SET 15 CHIAVI COMBinate A CRICCO REVERSIBILI IN BOX DI CARTONE**

CONTENUTO:  
6,7,8,9,10,11,12,13,14,15,16,17,18,19,22 mm

**CHIAVE COMBINATA A CRICCO REVERSIBILE CON ANELLO DI TENUTA**

ANELLO IN ACCIAIO INTEGRATO CHE CONSENTE LA TENUTA DEL BULLONE



LEVA DI INVERSIONE A FILO TESTA E CON LINGUETTA INCLINATA VERSO IL BASSO PER UN MAGGIORE SPAZIO DI MANOVRA

**FG 605/ST9-B**

**SET 9 CHIAVI A CRICCO REVERSIBILI CON SUPPORTO IN ABS**

CONTENUTO: 8,10,11,12,13,14,15,17,19mm

~~190,00€~~ **109,00€**

**FG 605/ST11-B**

**SET 11 CHIAVI A CRICCO REVERSIBILI CON SUPPORTO IN ABS**

CONTENUTO: 8,9,10,11,12,13,14,15,16,17,19mm

~~232,00€~~ **129,00€**



1/4"

**FG 624/MCR**

~~36,80€~~

**21,90€**

**MINI CRICCHETTO CON ATTACCO QUADRO MASCHIO 1/4" A 72 DENTI**



1/4"

**FG 624/MCH**

~~36,80€~~

**21,90€**

**MINI CRICCHETTO CON ATTACCO QUADRO FEMMINA 1/4" A 72 DENTI**



- Modello con testa chiusa anti polvere
- Leva di inversione integrata a filo testa
- Corpo scavato di 13° per consentire l'utilizzo anche in spazi particolarmente difficoltosi

- Meccanismo a 72 denti
- Cromatura lucida e asola di aggancio

**FG 625/FR12**

1/2"

**CRICCHETTO REVERSIBILE DA 1/2"**

~~57,80€~~

**33,90€**

**FG 624/FR14**

1/4"

**CRICCHETTO REVERSIBILE DA 1/4"**

~~43,50€~~

**24,90€**



- Sistema di inversione a ghiera integrato sulla testa

- Meccanismo a 72 denti
- Cromatura lucida
- Asola di aggancio

**FG 624/CR14**

1/4"

**CRICCHETTO REVERSIBILE DA 1/4" CON IMPUGNATURA BI-MATERIAL**

~~40,80€~~

**23,90€**

**FG 625/CR12**

1/2"

**CRICCHETTO REVERSIBILE DA 1/2" CON IMPUGNATURA BI-MATERIAL**

~~54,80€~~

**31,90€**



- Sistema di avanzamento rotativo integrato nell'impugnatura

- Meccanismo a 60 denti
- Cromatura lucida e asola di aggancio

**FG 624/RT14**

1/4"

**CRICCHETTO REVERSIBILE DA 1/4" CON IMPUGNATURA ROTANTE**

~~65,80€~~

**38,90€**

**FG 625/RT12**

1/2"

**CRICCHETTO REVERSIBILE DA 1/2" CON IMPUGNATURA ROTANTE**

~~82,80€~~

**49,90€**



**FG 624/S29**

**1/4"**

**SET 29 UTENSILI DA 1/4"**

~~210,00€~~

**129,00€**



4,5,6,7,8,9,10,  
11,12,13,14mm



FG 624/CR14



FG 624/PA50, 100



FG 624/PRF150



FG 624/ES14



FG 624/SN14



FG 624/GR14C



**FG 624/S45**

**1/4"**

**SET 45 UTENSILI DA 1/4"**

~~210,00€~~

**129,00€**



4,5,6,7,8,9,10,  
11,12,13,14mm



FG 624/CR14



FG 624/ES14



FG 624/PA50, 100



FG 624/PRF150



FG 624/SN14



FG 624/GR14C



FG 148/H, FG 148/TX, 1.5-10, 8-40,  
FG 148/PH, FG 148/F 1-4, 1-5



**FG 624/S25A**

**1/4"**

**SET 25 UTENSILI CON  
ATTACCO QUADRO 1/4"**

~~85,00€~~

**49,90€**



FG 624/E: 5, 6, 8, 10, 11, 13mm



FG 624/MCH14



ADATTATORE 1/4"x1/4"



FG 85/25PH1, PH2, PH3



FG 85/25PZ1, PZ2, PZ3



FG 85/25F3, F5



FG 85/25H4, H5, H6



FG 85/25TX10, TX15, TX20, TX25, TX30, TX40



**FG 624/S25**

**1/4"**

**SET 25 UTENSILI  
CON ATTACCO QUADRO 1/4"**

~~90,00€~~

**49,90€**



FG 624/E: 6, 8, 10, 11, 12, 13mm



FG 624/CR14



FG 89/38P11 (1/4x1/4)



FG 85/25PH1, PH2, PH3



FG 85/25PZ1, PZ2, PZ3



FG 85/25F4, F5, F6, F7



FG 85/25TX10, TX15, TX20, TX25, TX30, TX40

# CHIAVI A BUSSOLA



## FG 625TX/S13

SET 13 CHIAVI A BUSSOLA SNODATE CON IMPRONTA TORX

CONTENUTO:

1/4": E4, E5, E6, E7, E8

3/8": E10, E12, E14, E16

1/2": E18, E20, E22, E24

~~160,00€~~ **69,00€**

1/4"

3/8"

1/2"



## FG 624B/TXS10

SET 10 CHIAVI A BUSSOLA EXTRA-LUNGHE TORX

CONTENUTO: E6, E7, E8, E10, E11, E12, E14, E16, E18, E20

~~135,00€~~ **49,00€**



## FG 624B/S80

~~200,00€~~ **99,00€**

SET 80 UTENSILI DA 3/8"

	FG 624/B8,9,10,11,12,13,14,15,16,17, 18,19,21,22,23
	FG 624B/L8,10,13,14,17,19
	FG 624/CR38
	FG 625/SN38
	FG149/H 3,4,5,6,7,8,10
	FG 149/TX 9,10,15,20,25,27,30,40
	FG 624/ES38
	FG 624B/PA75,125,150,250
	FG 600B/8,10,13,15,17,19
	FG 89/50PI2 3/8"x1/4"
	FG 85/25PH 1,2,3 FG 85/25PZ 1,2,3 FG 85/25SL 3,4,4,5,5,5,5,6,6,5 FG 85/H 1,5,2,2,5,3,4,5,6 FG 85/25T 9,10,15,20,25,27,30,40 FG 88/60PI2



## FG 625/S27

~~190,00€~~ **99,00€**

SET 27 UTENSILI DA 1/2"

	FG 625/A8,9,10,11,12,13,14,15,16,17, 18,19,20,21,22,23,24,25,26,27,30,32
	FG 625/CR12
	FG 625/SN12
	FG 625/ES12
	FG 625/PA125, 250

# FG BEST 108

1/4"

1/2"

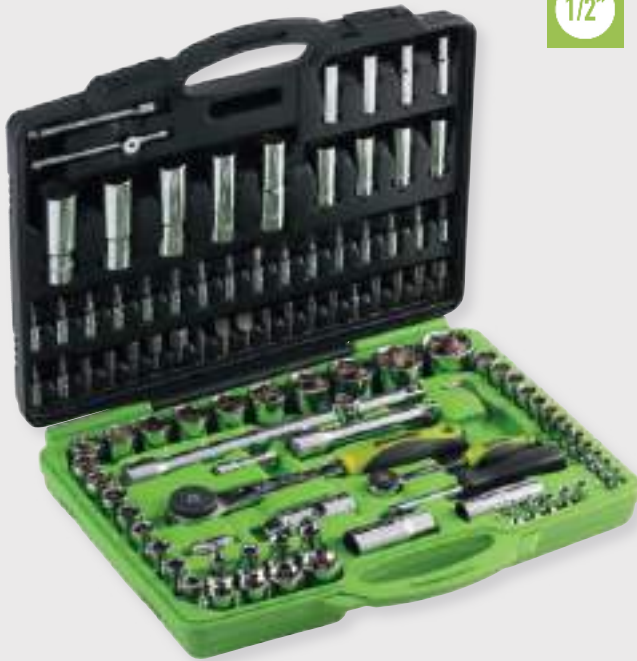

## FG BEST 108

~~270,00€~~

**139,00€**

### SET 108 UTENSILI DA 1/4" 1/2"

	FG 625/A10,11,12,13,14,15,16,17,18,19,20,21,22,23,24,27,30,32		FG 87/AD
	FG 624/E4,4.5,5.5,6,7,8,9,10,11,12,13,14		FG 181/B16,21 x CANDELE ACCENSIONE
	FG 625L/A14,15,17,19,22		FG 624/CR14 FG 625/CR12
	FG 624E/L6,7,8,9,10,11,12,13		FG 625/SN12 FG 624/SN14
	FG 625/TX10,11,12,14,16,18,20,24		FG 625/ES12 FG 624/ES14
	FG 624/TX4,5,6,7,8		FG 624/GR14
	FG 139/D1.5,2,2.5		FG 625/PR125 FG 624/PR50,100
	FG 147/PH1,PH2 FG 147/PZ1,PZ2 FG 147/SL4,SL5.5,SL6.5 FG 147/H3,H4,H5,H6 FG 147/TX10,TX15,TX20,TX25,TX30		
	FG 85/PH3,PH4 FG 85/PZ3,PZ4 FG 85/SL8,SL10,SL12 FG 85/H7,H8,H10,H12,H14 FG 85/TX40,TX45,TX50,TX55,TX60		

# FG BEST 171

1/4"

3/8"

1/2"



## FG BEST 171

~~400,00€~~

**189,00€**

### SET 171 UTENSILI DA 1/4", 3/8" E 1/2"

	FG 625/A10,11,12,13,14,15,16,17,18,19,20,21,22,23,24,27,30,32		FG 87/AD
	FG 624/B10,11,12,13,14,15,16,17,18,19		FG 181/B16,21 x CANDELE ACCENSIONE
	FG 624/E4,4.5,5.5,6,7,8,9,10,11,12,13,14		FG 625/SN12 FG 624/CR38 FG 624/SN14
	FG 625L/A16,17,18,19,22 FG 624B/L10,11,12,13,14,15 FG 624/4,5,6,7,8,9,10		FG 625/ES12 FG 624/ES14
	FG 625/TX20,24 FG 624B/TX10,11,12,14,16,18 FG 624/TX4,5,6,7,8		FG 624/GR14
	FG 181/B16,21 x CANDELE ACCENSIONE		FG 625/PR125 FG 624B/PR125 FG 624/PR50,PR100
	FG 624/CR14 FG 624/CR38 FG 625/CR12		FG 139/D1.1,1.5,2,2.5,3,4,4.5,5
	FG 147/PH0,PH1,PH2 FG 147/PZ0,PZ1,PZ2 FG 147/SL4,5.5,6.5,7 FG 147/H3,H4,H5 FG 147/TX8-TX30 FG 147/RTX8-RTX30		
	FG 85/PH3,PH4 FG 85/PZ3,PZ4 FG 85/SL8,SL10,SL12 FG 85/H7,H8,H10,H12,H14 FG 85/TX40-TX50 FG 85/TT10-TT45 FG 85/M5-M9		



# CHIAVI A BUSSOLA

**FG 625/S74**

~~250,00€~~

**129,00€**

SET 74 UTENSILI CON AGGANCIO 1/4" E 1/2"



1/4"

1/2"



FG 625/A8,9,10,11,12,13,14,15,16,17,18,19,20,21,22,23,24,25,26,27,30,32



FG 624/E4,5,6,7,8,9,10,11,12,13,14



FG 624/CR14  
FG 625/CR12



FG 625/SN12  
FG 624/SN14



FG 625/ES12  
FG 624/ES14



FG 624/GR14C



FG 625/PA125  
FG 624/PA50, 100



FG 89/38PI1 1/4"x1/4"



FG 85/25PH1, PH2, PH3  
FG 85/25SL3, SL4, SL4.5, SL5, SL5.5, SL6, L6.5  
FG 85/25PZ1, PZ2, PZ3  
FG 85/H1.5, H2, 2.5, H3, H4, H5, H6  
FG 85/25T9, T10, T15, T20, T25, T27, T30, T40

**FG 625/S94**

~~300,00€~~

**149,00€**

SET 94 UTENSILI CON AGGANCIO 1/4" E 1/2"



1/4"

1/2"



FG 625/A8,9,10,11,12,13,14,15,16,17,18,19,20,21,22,23,24,25,26,27,30,32



FG 624/E4,5,6,7,8,9,10,11,12,13,14



FG 625L/A10,13,14,15,17,19



FG 624E/L4,5,6,7,8,9,10,11,12,13,14



FG 624/CR14  
FG 625/CR12



FG 625/SN12  
FG 624/SN14

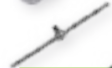

FG 625/ES12  
FG 624/ES14



FG 624/GR14C



FG 625/PA125, 250  
FG 624/PA50, 100



FG 89/38PI1 1/4"x1/4"



FG 85/25PH1, PH2, PH3  
FG 85/25SL3, SL4, SL4.5, SL5, SL5.5, SL6, L6.5  
FG 85/25PZ1, PZ2, PZ3  
FG 85/H1.5, H2, 2.5, H3, H4, H5, H6  
FG 85/25T9, T10, T15, T20, T25, T27, T30, T40  
FG 88/60PI2

**FG 625/S110**

**SET 110 UTENSILI DA 1/4" 1/2"**

~~478,00€~~

**249,00€**



1/4"

1/2"

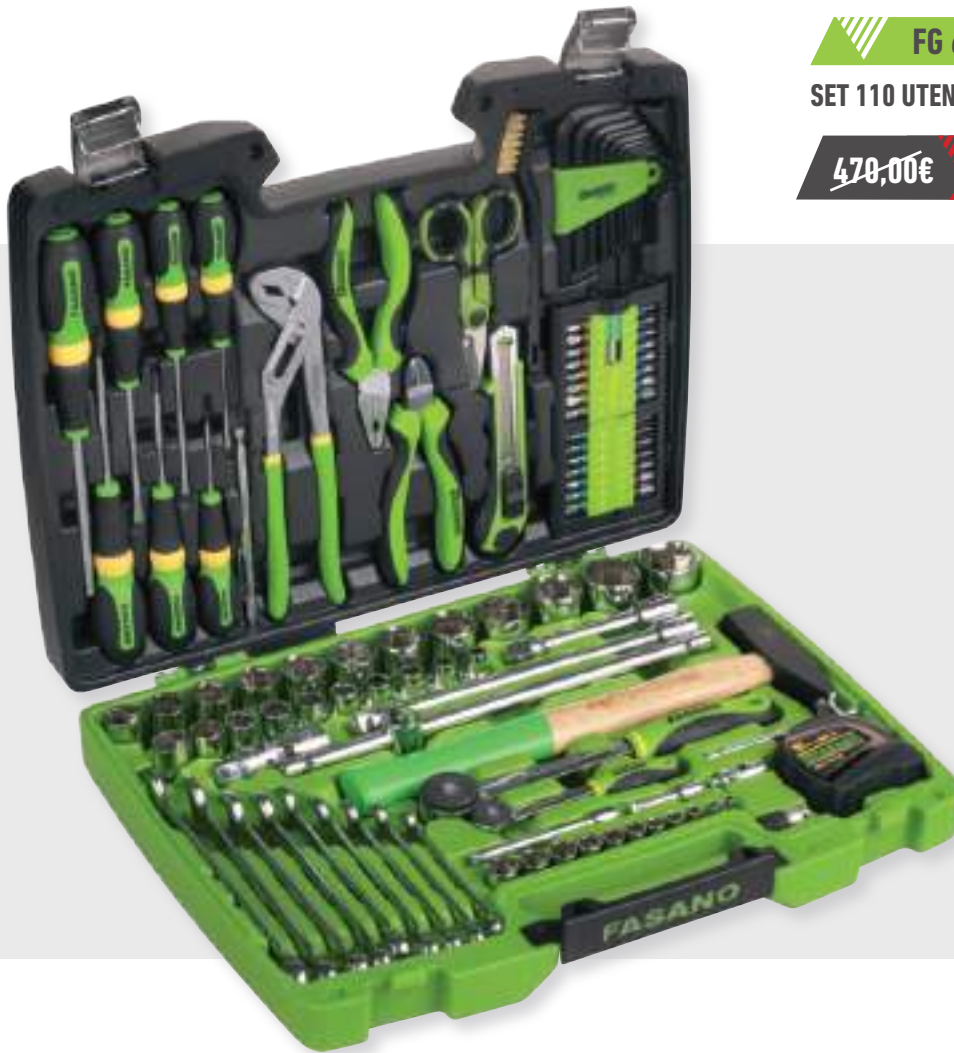

FG 625/A8,9,10,11,12,13,14,15,16,17,  
18,19,20,21,22,23,24,25,26,27,30,32



FG 624/E4,5,6,7,8,9,10,11,12,13,14



FG 624/CR14  
FG 625/CR12



FG 625/SN12  
FG 624/SN14



FG 625/ES12  
FG 624/ES14



FG 624/GR14C



FG 625/PA125, 250  
FG 624/PA50, 100



FG 89/38PI1 1/4"x1/4"



FG 85/25PH1, PH2, PH3  
FG 85/25SL3, SL4, SL4.5, SL5, SL5.5, SL6, L6.5  
FG 85/25PZ1, PZ2, PZ3  
FG 85/H1.5, H2, 2.5, H3, H4, H5, H6  
FG 85/25T9, T10, T15, T20, T25, T27, T30, T40  
FG 88/60PI2



FG 139/B



FG 48/L



FG 49



FG 600/B8,10,11,12,13,14,15,17,19



FG 22/3x75, 4x100, 5.5x100  
FG 22/PH0x60, PH1x80, PH2x100



FG 59SR/160  
FG 63SR/160



FG 58/B240



FG 132/H500



FG 79/SP



FG 92/PM1

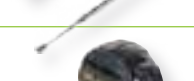

FG 44/MT5



# CHIAVI A BUSSOLA



**FG 150TX/S32**

~~195,00€~~

**119,00€**

1/2"

SET 32 INSERTI A BUSSOLA TORX DA 1/2"



FG 150/TX20 - TX70

FG 150L/TX20 - TX70

FG 150XL/TX40 - TX70

FG 150XXL/TX40 - TX70

FG 150XXL/TX40 - TX70

**FG 150M/S26**

~~180,00€~~

**109,00€**

SET 26 INSERTI A BUSSOLA XZN DA 1/2"



1/2"



FG 150/M5 - M16

FG 150L/M5 - M16

FG 150XL/M5 - M14

FG 150XXL/M8 - M14

**FG 150H/S30**

~~200,00€~~

**119,00€**

SET 30 INSERTI A BUSSOLA ESAGONALI DA 1/2"

1/2"



FG 150/H5 - H19

FG 150L/H5 - H13

FG 150XL/H5 - H14

FG 150XXL/H5 - H12



**FG 629A/S15**

3/4"

SET BUSSOLE ESAGONALI DA 3/4" + ACCESSORI

~~600,00€~~

**339,00€**

19,22,23,27,30,32  
36,41,46,50, 60mm

FG 629/CR34

FG 629/SN34

FG 629/ES34

FG 629/PR200

**FG 629B/S15**

3/4"

SET BUSSOLE POLIGONALI DA 3/4" + ACCESSORI

~~618,00€~~

**339,00€**



**EXTRA-PIATTA**

CHIAVI A BUSSOLA 1/2" ESAGONALI RINFORZATE



1/2"

**FG 628/S12**



SET 12 CHIAVI A BUSSOLA RINFORZATE DA 1/2" SU SUPPORTO IN PLASTICA

CONTENUTO: 10, 11, 12, 13, 14, 15, 16, 17, 18, 19, 20, 21 mm mm

~~130,00€~~ **79,00€**



1/2"

**FG 628/S6**



SET 6 CHIAVI A BUSSOLA RINFORZATE DA 1/2" SU SUPPORTO IN PLASTICA

CONTENUTO: 22, 23, 24, 27, 30, 32mm

~~95,00€~~ **55,00€**



3/4"

**FG 629C/S10**



SET 10 CHIAVI A BUSSOLA RINFORZATE ESAGONALI DA 3/4" IN CASSETTA DI ACCIAIO

CONTENUTO: 17, 19, 22, 24, 27, 30, 32, 36, 41, 46mm

~~299,00€~~ **159,00€**



1/2"

**FG 152/RTXS10**

~~165,00€~~ **99,00€**

SET 10 INSERTI A BUSSOLA RINFORZATI TORX DA 1/2" SU SUPPORTO IN PLASTICA

CONTENUTO: TX20, TX25, TX27, TX30, TX40, TX45, TX50, TX55, TX60, TX70



1/2"

**FG 152RM/S9**

~~125,00€~~ **69,00€**

SET 9 INSERTI A BUSSOLA XZN RINFORZATI DA 1/2" SU SUPPORTO IN PLASTICA

CONTENUTO: RM5, RM6, RM8, RM9, RM10, RM12, RM14, RM16, RM18



1/2"

**FG 152RH/S9**

~~125,00€~~ **69,00€**

SET 9 CHIAVI A BUSSOLA RINFORZATE DA 1/2" ESAGONALI SU SUPPORTO IN PLASTICA

CONTENUTO: XZN5, 6, 8, 9, 10, 12, 14, 16, 18



1"

**FG 630A/S14**

~~830,00€~~ **499,00€**

SET 14 CHIAVI A BUSSOLA ESAGONALI RINFORZATE - ATTACCO 1"

CONTENUTO: 24,27,30,32,33,34,36,38,41,46,50,55,60,65mm



## FG 22/S6

**CONTENUTO:** 3x75, 4x100, 5.5x100, PH0x60, PH1x80, PH2x100

~~36,80€~~ **21,50€**



## FG 22/S8

**CONTENUTO:** 3x75, 4x100, 5.5x100, 6.5x30 PH0x60, PH1x80, PH2x100, PH2x30

~~48,80€~~ **27,90€**



## FG 22/S8B

**CONTENUTO:** 2.5x75, 3.5x100, 4x100, 6.5x150, 8x150, PH0x60, PH1x80, PH2x150

~~52,80€~~ **31,90€**



## FG 22/S10

**CONTENUTO:** 2.5x60, 3x75, 4x100, 5.5x150, 6.5x150, 4x30, PH0x60, PH1x80, PH2x100, PH1x30

~~65,80€~~ **37,90€**



## FG 22/S12

**CONTENUTO:** 2.5x60, 3x75, 4x100, 5.5x150, 6.5x150, 8x150, 4x30, PH0x60, PH1x80, PH2x100, PH3x150, PH1x30

~~90,80€~~ **53,90€**



## FG 22/S7

**CONTENUTO:** 3x75, 4x100, 5.5x150, 6.5x150, PZ0x60, PZ1x80, PZ2x100, 3x75, 4x100, 5.5x150, 6.5x150, PZ0x60, PZ1x80, PZ2x100

~~50,80€~~ **29,90€**



**FG 22TX/S6**

~~65,00€~~ **38,90€**

**CONTENUTO:** RTX10, RTX15, RTX20, RTX25, RTX27, RTX30



**FG 22TX/LS11**

~~155,00€~~ **89,00€**

**CONTENUTO:** TX6, 7, 8, 9, 10, 15, 20, 25, 27, 30, 40



**FG 139/B**

**SET 10 CHIAVI MASCHIO A L ESAGONALI - SERIE CORTA**

1.5, 2, 2.5, 3, 4, 5, 5.5, 6, 8, 10mm

~~16,50€~~ **9,90€**

**FG 139/C**

**SET 10 CHIAVI MASCHIO A L ESAGONALI - SERIE LUNGA**

1.5, 2, 2.5, 3, 4, 5, 6, 8, 10mm

~~23,70€~~ **13,90€**



**FG 139**

**SET 12 CHIAVI MASCHIO A L ESAGONALI - SERIE SFERICA**

1.5, 2, 2.5, 3, 4, 4.5, 5, 5.5, 6, 7, 8, 10mm

~~36,00€~~ **21,90€**

**FG 139/L**

**SET 12 CHIAVI MASCHIO A L ESAGONALI - SERIE LUNGA**

1.5, 2, 2.5, 3, 4, 4.5, 5, 5.5, 6, 7, 8, 10mm

~~40,00€~~ **23,90€**



TESTA SFERICA

**FG 139C/FS**

**SET 8 CHIAVI MASCHIO CON IMPRONTA ESAGONALE SFERICA - SERIE CORTA**

1.5, 2, 2.5, 3, 4, 5, 6, 8mm

~~24,00€~~ **12,90€**

**FG 139FS/IN**

**SET 9 CHIAVI MASCHIO CON IMPRONTA ESAGONALE - SERIE IN POLLICI**

5/64, 3/32, 7/64, 1/8, 9/64, 5/32, 3/16, 7/32, 1/4"

~~24,00€~~ **12,90€**



**FG 139/IN**

**SET 13 CHIAVI MASCHIO A L CON IMPRONTA ESAGONALE SFERICA - IN POLLICI**

0.05 - 3/8"

~~38,00€~~ **22,90€**



TESTA SFERICA



**FG 138/BP**

**SET 9 CHIAVI MASCHIO TORX A L E TESTA SFERICA**

**CONTENUTO:**  
TX8, 10, 15, 20, 25, 27, 30, 40, 50

~~60,00€~~ **35,90€**

**TESTA SFERICA**



**FG 138**

**SET 12 CHIAVI MASCHIO TORX A L**

**CONTENUTO:**  
TX7, X8, 9, 10, 15, 20, 25, 27, 30, 40, 45, 50

~~55,00€~~ **29,90€**



**FG 139/LM**

**SET 10 CHIAVI MASCHIO A L ESAGONALI MAGNETICHE**

**CONTENUTO:** 1.5, 2, 2.5, 3, 4, 5, 6, 7, 8, 10mm

~~52,00€~~ **30,90€**

**ESTREMITÀ MAGNETICA**



**FG 138/M**

**SERIE 10 CHIAVI MASCHIO A L TORX MAGNETICHE**

**CONTENUTO:** TX9 - TX50

~~60,00€~~ **35,90€**

**ESTREMITÀ MAGNETICA**



**FG 138/B**

**SET 10 CHIAVI MASCHIO A L CON IMPRONTA TORX**

**CONTENUTO:** TX9 - TX50 - SERIE CORTA

~~34,00€~~ **16,90€**

**FG 138/C**

**SET 10 CHIAVI MASCHIO A L CON IMPRONTA TORX**

**CONTENUTO:** TX9 - TX50 - SERIE LUNGA

~~37,00€~~ **19,90€**

**NEW**



**FG 85/S100**

**SET 98 INSERTI DA 1/4" + 2 PORTA INSERTI**

**CONTENUTO:**  
PH 0, 1, 2, 3; PZ 0, 1, 2, 3; Tri-Wing 1, 2, 3, 4, 6, 8, 10; XZN 5, 6, 8; TX 8, 9, 10, 15, 20, 25, 27, 30, 40, 45; S 0, 1, 2, 3; TX 8, 10, 15, 20, 25, 27, 30, 35, 40; SL 3, 4, 4.5, 5, 5.5, 6, 6.5, 7; H 1.5, 2, 2.5, 3, 4, 5, 5.6, 1/16, 5/64, 3/32, 7/64, 1/8, 9/64, 5/32, 3/16, 7/32, 1/4; HTR 2, 2.5, 3, 4, 5, 6, 5/64, 3/32, 7/64, 1/8, 9/64, 4, 5/32; SP 4, 6, 8, 10; SP 5/32, 3/16, 1/4



~~98,00€~~ **59,00€**

**FG 56/S3**
~~89,30€~~ **53,90€**
**SET 3 PINZE A BECCHI LUNGI ZIGRINATI -L: 270MM**
**CONTENUTO:** FG 56/0, FG 56/45, FG 56/90

**FG 57/S3**
~~116,80€~~ **69,90€**
**SET 3 PINZE A BECCHI LUNGI ZIGRINATI -L: 270MM**
**CONTENUTO:** FG 57/0, FG 57/45, FG 57/90

**FG 58/A240**
**PINZA REGOLABILE A CERNIERA CHIUSA CON PULSANTE DI SGANCIO RAPIDO**
~~42,80€~~ **24,90€**

**FG 58/B...**
**PINZA REGOLABILE A CERNIERA CHIUSA SEMPLICE**

CODICE	MM - INCH	LISTINO	€/PROMO
FG 58/B180	180-7"	29,00	16,90
FG 58/B240	240-10"	33,50	19,90
FG 58/B300	300-12"	47,00	27,90

**FG 59XT/S3**
~~89,50€~~ **49,90€**
**SET 3 PINZE ASSORTITE**
**CONTENUTO:** FG 59/XT180, FG 61/XT160, FG 63/XT160

**FG 59XT/S3B**
~~99,50€~~ **58,90€**
**SET 3 PINZE ASSORTITE**
**CONTENUTO:** FG 59/XT180, FG 61/XT200, FG 63/H180

**FG 59PV/S3**
~~72,80€~~ **39,90€**
**SET 3 PINZE, CON MANICI IN DOPPIO STRATO DI PVC**
**CONTENUTO:** FG 59PV/160, FG 61PV/160, FG 63PV/160

**FG 59PV/S3B**
~~79,80€~~ **44,90€**
**SET 3 PINZE, CON MANICI IN DOPPIO STRATO DI PVC**
**CONTENUTO:** FG 59PV/180, FG 61PV/200, FG 63PV/H180

**FG 51/S4**
~~99,80€~~ **55,90€**
**SET 4 PINZE PER ANELLI ELASTICI 10-25MM**
**FG 51/S4B**
~~105,80€~~ **61,90€**
**SET 4 PINZE PER ANELLI ELASTICI 19-60MM**
**"INSERTI RINFORZATI PER ANELLI DI GRANDE TENUTA"**

**FG 55/S4**
~~136,50€~~ **76,00€**
**SET 4 PINZE PER ANELLI ELASTICI CON INSERTI RINFORZATI IN ACCIAIO 10-25MM**
**FG 55/S4B**
~~141,80€~~ **79,90€**
**SET 4 PINZE PER ANELLI ELASTICI CON INSERTI RINFORZATI IN ACCIAIO 19-60MM**



## FG 22E/S6

### SET 6 GIRAVITI ISOLATI

**CONTENUTO:** 3X100, 4X100, 5.5X125, PH0X60, PH1X80, PH2X100



~~58,00€~~ **33,90€**



## FG 22E/SZ6

### SET 6 GIRAVITI ISOLATI

**CONTENUTO:** 3x100, 4x100, 5.5x125 PZ0x60, PZ1x80, PZ2x100



~~58,00€~~ **33,90€**



## FG 59IS/S3

### SET 3 PINZE CON MANICI ISOLATI

**CONTENUTO:** FG 59/IS180, FG 61/IS200, FG 63/IS160



~~118,50€~~ **62,90€**



## FG 68U/S439

**SET PINZA UNIVERSALE + 3 MATRICI (FG 68/MAT4, MAT16, MAG) CON ASSORTIMENTO 435 CAPICORDA ISOLATI**

~~228,00€~~ **169,00€**



**FG 96/DG**
~~185,00€~~ **109,00€**
**MULTIMETRO DIGITALE DC/AC - OHM**

**CARATTERISTICHE TECNICHE:**

Classe II  
 Categoria sovratensione: CAT III 300V  
 Test di continuità  
 Frequenza: 10Hz-200kHz  
 Prova diodi  
 Duty cycle 5%-95% RH ( $\pm 0.1\%$ )  
 Temperatura - 20°C/400°C ( $\pm 1.5\% \pm 3.0^\circ\text{C}$ )  
 / 400°C/1000°C ( $\pm 2.0\% \pm 3.0^\circ\text{C}$ )  
 Misurazione Lux 4.000 Lux ( $\pm 1$ ) / 40.000 Lux ( $\pm 10$ )  
 Capacità rilevazione umidità 30%-90% RH ( $\pm 0.1\%$ )  
 Capacità di rilevazione suono 35 - 100dB ( $\pm 0.1\text{dB}$ )  
 Stand by dopo 15 minuti  
 Indicatore di livello batteria  
 Batteria da 9 V



DC	AC	$\Omega$	LXPXH/MM
400mV-300V	4V-300V	400 $\Omega$ -40M $\Omega$	8x3.5x16.5

**FG 97/DG**
~~135,00€~~ **79,00€**
**MULTIMETRO DIGITALE DC/AC - OHM**

**CARATTERISTICHE TECNICHE:**

Classe II  
 Categoria sovratensione: CAT III 600V  
 Prova diodi  
 Alimentazione: 1 batteria tipo AAA da 1.5V

**NEW**

DC	AC	$\Omega$	LXPXH/MM
600mV-600V	6V-600V	600 $\Omega$ -60M $\Omega$	148x76x21

**FG 98/DG**
~~340,00€~~ **199,00€**
**MULTIMETRO DIGITALE DC/AC - OHM**

**CARATTERISTICHE TECNICHE:**

Classe II  
 Categoria sovratensione: CAT IV 600V; CAT III 1000V  
 Frequenza: 100 kHz  
 Prova diodi  
 Alimentazione: 1 batteria da 9V

**NEW**

DC	AC	$\Omega$	LXPXH/MM
200mV-1000V	2V-750V	200 $\Omega$ -20M $\Omega$	184x90x46

**FG 99/DG**
~~250,00€~~ **149,00€**
**PINZA AMPEROMETRICA DIGITALE**

**CARATTERISTICHE TECNICHE:**

Classe II  
 Categoria sovratensione: CAT III 600V  
 Temperatura: -20°C ÷ 1000°C (-4°F ÷ 1832°F)  
 Frequenza: 10Hz; 100Hz; 1000Hz; 10kHz; 100kHz;  
 1000kHz; 10MHz  
 Prova diodi  
 Alimentazione: 3 batterie da 1.5V TIPO AAA

**NEW**

DC	AC	$\Omega$	LXPXH/MM
600mV-600V	6V-600V	600 $\Omega$ -60M $\Omega$	194x59x29



**CHIAVI DINAMOMETRICHE A DISINNESTO E ATTACCO QUADRO**  
Fornita con certificato di taratura

CODICE	RISOLUZIONE	NM	LISTINO	€/PROMO	
FG 531	0.1Nm	5-25Nm	215,00	125,00	1/4"
FG 533/2	0.25Nm	10-50Nm	240,00	139,00	3/8"
FG 536/1	0.5Nm	20-100Nm	240,00	139,00	1/2"
FG 536/2	1.0Nm	40-200Nm	250,00	145,00	1/2"
FG 536/3	2.0Nm	60-340Nm	265,00	159,00	1/2"
FG 540/1	2.5Nm	150-750Nm	1.050,00	629,00	3/4"
FG 540/2	2.5Nm	200-1.000Nm	1.200,00	719,00	3/4"



**CHIAVE DINAMOMETRICA A INNESTO FEMMINA 9X12MM**  
Precisione  $\pm 4\%$   
Fornita con certificato di taratura

CODICE	RISOLUZIONE	NM	□ x ■	LISTINO	€/PROMO
FG 544/1	0.1Nm	5-25Nm	9x12	195,00	119,00
FG 544/2	0.25Nm	10-50Nm	9x12	216,00	129,00
FG 544/3	0.5Nm	20-100Nm	9x12	232,00	139,00
FG 544/4	1.0Nm	40-200Nm	14x18	278,00	159,00



**BARRE DINAMOMETRICHE A DISINNESTO E ATTACCO QUADRO**  
Fornita con certificato di taratura

CODICE	NM	LISTINO	€/PROMO	
FG 538/1	140-560	800,00	469,00	3/4"
FG 538/2	200-800	800,00	529,00	3/4"
FG 539/1	200-1.000	1.150,00	679,00	1"

GRADO DI PRECISIONE:  $\pm 4\%$       FORNITA IN CASSETTA DI ABS

**CHIAVI DINAMOMETRICHE  
DIGITALI PER NM E GRADI**  
Fornita con certificato di taratura

1/2"

CODICE	NM	LISTINO	€/PROMO
FG 543/DG1	16.8-135	650,00	389,00
FG 543/DG2	10-200	770,00	459,00

- Doppia modalità di misurazione: PICCO e TRACCIA
- Indicatore sonoro e visivo a 12 led al raggiungimento della coppia prefissata
- Possibilità di memorizzare fino a 250 differenti serraggi grazie al software PC incluso nel kit Interfaccia PC tramite presa USB
- Possibilità di impostare fino a 9 serraggi predefiniti
- Alimentazione: 2 batterie 1.5V (incluse)

1/2"
**FG 546/DG**
~~320,00€~~ **195,00€**
**GONIOMETRO DIGITALE PER  
SERRAGGI IN COPPIA E ANGOLARI**
**PRECISIONE DI SERRAGGIO: ± 2%**

Doppia modalità di misurazione:  
PICCO e TRACCIA  
Indicatore sonoro e visivo a 6 led al  
raggiungimento della coppia prefissata  
Possibilità di memorizzare fino a 50 serraggi differenti  
Alimentazione: 2 batterie 1.5V (incluse)

**FG 547/DG**
~~205,00€~~ **125,00€**
**GONIOMETRO DIGITALE  
PER SERRAGGI ANGOLARI**
**PRECISIONE DI SERRAGGIO: ± 2%**

Indicatore sonoro e visivo a 6 led al  
raggiungimento della coppia prefissata  
Dotato di supporto magnetico posteriore

**MINI MOLTIPLICATORE DI COPPIA  
DESTRO/SINISTRO**

 1/2" x 1/2"  
Rapporto: 3.4:1

CODICE	NM	MASSIMA USCITA	LISTINO	€/PROMO
FG 580/A	445	600	270,00	99,00
FG 580/B	590	800	370,00	129,00

**GIRAVITE DINAMOMETRICO  
A TARATURA LIBERA**

1/4"

CODICE	NM	L/MM.	LISTINO	€/PROMO
FG 559/1	0.1- 1.2	155	220,00	125,00
FG 559/2	1 - 6	155	230,00	135,00

**PRECISIONE DI SERRAGGIO: ± 6%**



**FG 70/S110**

~~335,00€~~ **199,00€**

**SET MASCHI E FILIERE IN ACCIAIO AL CROMO + ACCESSORI - 110PZ**  
PASSO GROSSO E FINE - FILETTATURA METRICA

					ACCESSORI	
2x0.04	6x0.75	12x1	2x0.4	6x0.75	12x1	GF25x9
3x0.5	7x0.75	12x1.25	3x0.5	7x0.75	12x1.25	GF8x14
4x0.7	8x0.75	12x1.5	4x0.7	8x0.75	12x1.5	GMM1.5
5x0.8	8x1	14x1	5x0.8	8x1	14x1	GMM3
6x1	9x0.75	14x1.25	6x1	9x0.75	14x1.25	GMC1
7x1	9x1	14x1.5	7x1	9x1	14x1.5	
8x1.25	10x0.75	16x1	8x1.25	10x0.75	16x1	
9x1.25	10x1	16x1.5	9x1.25	10x1	16x1.5	
10x1.5	10x1.25	18x1.5	10x1.5	10x1.25	18x1.5	
11x1.5	11x0.75		11x1.5	11x0.75		
12x1.75	11x1		12x1.75	11x1		
14x2	11x1.25		14x2	11x1.25		
16x2	12x0.75		16x2	12x0.75		



**FG 75TIN/S25**

**SET 25 PUNTE ELICOIDALI CILINDRICHE IN ACCIAIO HSS -TIN 5% RETTIFICATE**  
1 - 13 X0,5MM

~~198,00€~~ **119,00€**



**FG 75CO/S25**

**SET 25 PUNTE ELICOIDALI CILINDRICHE IN ACCIAIO HSS -COBALTO 5% RETTIFICATE**  
1 - 13 X0,5MM

~~236,00€~~ **139,00€**



**FG 80HSS/S3**

**SET 3 FRESE CONICHE IN ACCIAIO HSS**  
APPLICAZIONE: LAMIERE D'ACCIAIO  
FORNITO IN BOX DI ABS DOTATO DI GANCIO DI APPENDIMENTO

~~145,00€~~ **89,00€**

**FG 49/L**

~~18,00€~~ **10,90€**

**FORBICE MULTIUSO A LAME LUNGHE IN ACCIAIO INOX**

L/MM 200  
APERTURA MAX 151MM  
HRC: 52-54



**FG 49/MU**

~~26,50€~~ **15,90€**

**FORBICI MULTIUSO CON GOLA SPELLAFILI E LAME IN ACCIAIO INOX ZIGRINATE**

HRC: 52-54



**FG 49/TC**

~~41,00€~~ **24,90€**

**FORBICE DA ELETTRICISTA, DOTATA DI INCAVO SPELLAFILI E CORPO INTEGRALMENTE IN ACCIAIO**

L/MM 140 - A/MM 65MM  
- LAMA MICRODENTATA IN ACCIAIO  
- HRC: 56  
- STRUTTURA INTEGRALE IN ACCIAIO INOX  
- TAGLIACAVI 12MM  
- CON SUPPORTO PER CINTURA



**STRUTTURA INTERAMENTE IN ACCIAIO FORGIATO**



**FG 49/TCX**

~~48,00€~~ **28,90€**

**FORBICE DA ELETTRICISTA, DOTATA DI INCAVO SPELLAFILI E CORPO INTEGRALMENTE IN ACCIAIO**

L/MM 160 - A/MM 50MM  
- LAMA MICRODENTATA IN ACCIAIO  
- HRC: 56  
- STRUTTURA INTEGRALE IN ACCIAIO INOX  
- TAGLIACAVI 15MM  
- CON SUPPORTO PER CINTURA



**STRUTTURA INTERAMENTE IN ACCIAIO FORGIATO**



**FG 77/PVC4**

~~70,00€~~ **29,00€**

**TRONCATUBI A CRICCO**

- SISTEMA A CREMAGLIERA CON AVANZAMENTO PROGRESSIVO  
- DOTATA DI PIATTAFORMA IN NYLON CHE FACILITA IL TAGLIO DI PROFILI PIATTI  
- Ø: 0-42MM

**TUBO IN PVC**



**TRONCABULLONI**

CODICE	L/MM-POLLICI	CAPACITA'	LISTINO	€/PROMO
FG 67/350	350-14"	3-10mm	48,00	29,00
FG 67/450	450-18"	5-16mm	61,00	36,90
FG 67/600	600-24"	8-22mm	82,50	49,90
FG 67/750	750-30"	9-25mm	107,00	64,90



# MANUTENZIONE GENERALE



FLESSOMETRO CON CASSA IN ABS ANTI-SHOCK E NASTRO IN ACCIAIO RIVESTITO IN NYLON - CLASSE II

CODICE	L/MM	BANDA	LISTINO	€/PROMO
FG 44/MT3	3	16MM	11,50	6,90
FG 44/MT5	5	25MM	18,00	10,90
FG 44/MT8	8	25MM	24,00	13,90
FG 44/MT10	10	25MM	29,00	16,90



CALIBRO A CORSOIO, LETTURA CINQUANTESIMALE  
SCALA CROMATA - ASTA SOTTILE - BLOCCAGGIO A VITE - INOX TEMPRATO

CODICE	L/MM	LISTINO	€/PROMO
FG 95/CA	150	52,00	29,90
FG 95/CA2	200	125,00	69,00



CALIBRO DI PROFONDITÀ, LETTURA CINQUANTESIMALE  
SCALA CROMATA - ASTA SOTTILE - BLOCCAGGIO A VITE - INOX TEMPRATO

**FG 95/CP1** ~~96,00€~~ **59,00€**



CALIBRO A CORSOIO, DIGITALE  
- L/MM: 150

**FG 95/DG** ~~95,00€~~ **55,00€**



MARTELLO TIPO TEDESCO CON MANICO IN RESINA

CODICE	gr	L/mm	LISTINO	€/PROMO
FG 132/200	200	294	18,50	10,90
FG 132/300	300	297	20,50	11,90
FG 132/500	500	312	21,50	12,90
FG 132/800	800	342	27,00	15,90
FG 132/1000	1000	343	29,50	17,90

**FG 127/S1**  
SET SCALPELLI E PUNZONI



~~49,50€~~ **28,90€**

**FG 128C/S6**  
SET 6 CACCIASPINE  
- MISURE: 2,3,4,5,6,8MM



~~46,50€~~ **27,90€**

**FG 128P/S6**  
SET 6 PUNZONI  
- MISURE: 1,2,3,4,5,6MM



~~41,50€~~ **24,90€**

**FG 712/L4**  
PORTA MINUTERIE A RIPIANI GIREVOLI  
- FORNITO CON DIVISORI INTERNI  
- DOTATO DI 4 RIPIANI GIREVOLI E VASCHETTA SUPERIORE PORTA MINUTERIE  
- MATERIALE: ABS RESISTENTE AGLI URTI  
- DOTATO DI 4 PIEDI D'APPOGGIO



~~120,00€~~ **49,00€**

**FG 47/S3**  
SET 3 RASCHIETTI  
A BATTERE CON LAMA  
IN ACCIAIO INOX



~~58,00€~~ **34,90€**

**FG 47/S4**  
SET 4 SPATOLE  
IN ACCIAIO INOX



~~21,50€~~ **12,90€**

**FG 92/PM4** ~~27,50€~~ **12,90€**  
PROLUNGA MAGNETICA  
TELESCOPICA (165-622MM)



**FG 92/GR**  
PROLUNGA MAGNETICA FLESSIBILE  
- CAPACITÀ 1KG - LUNGHEZZA: 700MM

CON GRIFFE PRENSILI



~~27,00€~~ **14,90€**

**FG 92/PF** ~~27,50€~~ **13,90€**  
PROLUNGA MAGNETICA CON ASTA FLESSIBILE  
CAPACITÀ 3.5KG

LUNGHEZZA  
ASTA: 400MM



1 metro

ASTA  
DA 1 METRO

**FG 92/PM**  
PROLUNGA MAGNETICA  
CON ASTA FLESSIBILE

~~19,00€~~ **11,50€**



CE



**FG 98/GAS**

**SALDATORE PORTATILE A GAS**  
 - TEMPERATURA MAX: 210-450°C  
 - 25 WATT  
 - AUTONOMIA: 120 MIN CONTINUATIVI  
 - FORNITO CON PUNTE PER SALDARE, TAGLIARE E SOFFIARE

~~125,00€~~ **75,00€**

CE



**FG 98/LT**

**SALDATORE PORTATILE CON BATTERIA AL LITIO**  
 - TEMPERATURA MAX: 600°C  
 - AUTONOMIA: 40MIN CONTINUATIVI  
 - TEMPO DI RICARICA: 3.5H  
 - FORNITO CON PUNTE PER SALDARE, TAGLIARE E SOFFIARE

~~170,00€~~ **99,00€**

**FG 96/SS36**

~~65,00€~~ **39,00€**

**SALDATORE A STILO A DOPPIA POTENZA**  
 CLASSE DI PROTEZIONE I



NEW

**FG 96/SS30**

**SALDATORE A STILO**  
 - 30 WATT - 230V - Ø/mm 4 - 430 °C  
 - CLASSE DI PROTEZIONE: I

~~48,00€~~ **29,90€**



CE

**FG 95/SP100**

~~65,00€~~ **39,00€**

**SALDATORE ISTANTANEO A PISTOLA 100W**  
 CLASSE DI PROTEZIONE II  
 FORNITO CON 1 PUNTA DI RICAMBIO E STAGNO PER SALDARE



**FG 96/SS60**

**SALDATORE A STILO**  
 - 60 WATT - 230V - Ø/mm 6 - 500 °C  
 - CLASSE DI PROTEZIONE: I

~~60,00€~~ **36,00€**

**FG 494/S12**

**PISTOLA PER COLLA A CALDO**

- KIT COMPLETO DI 12 STICK  
DI COLLA TERMOFUSIBILE

~~55,00€~~ **32,90€**



- POTENZA NOMINALE DI RISCALDAMENTO: 80W
- TEMPERATURA DI ESERCIZIO: 193°C (383°F)
- TEMPO DI RISCALDAMENTO: 3/5 MIN
- LUNGHEZZA STICK COLLA: 200MM
- DIAMETRO STICK COLLA: 11.5MM



**FG 93/M50**

**SPECCHIETTO TELESCOPICO  
E ARTICOLATO IN ACCIAIO**



~~30,00€~~ **17,90€**

**FG 93/M95**

**SPECCHIETTO TELESCOPICO  
E ARTICOLATO IN ACCIAIO**



~~30,00€~~ **17,90€**

**FG 125/S3**

**SET 3 LEVE IN ACCIAIO  
CON TESTA A BATTERE**

CONTENUTO: 300, 450, 600MM

~~68,00€~~ **39,90€**



**PISTOLA A LEVA PER GRASSO**

UTILIZZABILE CON GRASSO IN CARTUCCIA E GRASSO SFUSO  
DOTATA DI CANNUCCIA RIGIDA E TUBO FLESSIBILE Ø 53MM



CODICE	CAPACITA' CC	L/mm TUBO	LISTINO	€/PROMO
FG 490/C500	500CC	320	52,00	31,20
FG 490/C800	800CC	500	65,00	39,00

**FG 493/AL**



**PISTOLA PER SIGILLANTE CON TUBO IN ACCIAIO**

CORPO PRINCIPALE E MECCANISMO  
INTERNO INTERAMENTE IN ACCIAIO

~~45,00€~~ **26,90€**

**FG 493/N**

**PISTOLA PER SIGILLANTE  
CON TUBO IN ALLUMINIO**

- DOTATA DI FUNZIONE  
ANTI-GOCCIA

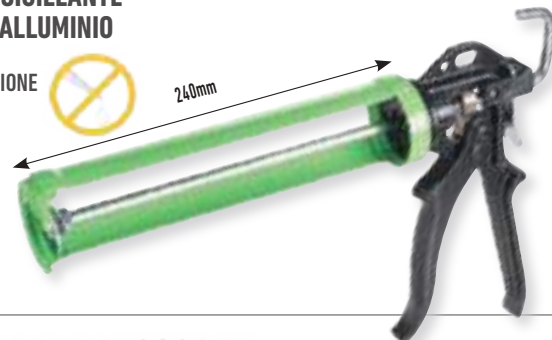

~~38,50€~~ **23,50€**

**FG 79/SP3**

**SPAZZOLA CON FILI RIGIDI IN ACCIAIO**

~~5,50€~~ **3,30€**



**FG 79/SP4**

**SPAZZOLA CON FILI IN ACCIAIO ONDULATO OTTONATO**

~~5,30€~~ **3,20€**



## FG 203

### MINI FARETTO PORTATILE A LED

DOTATO DI MAGNETI POSTERIORI, FUNZIONE DI GESTIONE DELL'INTENSITA', DOPPIA PORTA PER RICARICA. INCLUSO CAVO DI RICARICA USB. **CORPO IN ALLUMINIO ANODIZZATO**  
FUNZIONE DIMMER



BASE MAGNETICA



DOPPIA PORTA DI RICARICA TIPO C E MICRO USB



**100 LUMEN**

~~25,00€~~

**12,90€**

## FG 204

MINI LAMPADA PORTATILE A LED  
BATTERIA AL LITIO LUNGA DURATA



**300 LUMEN**



DOTATA DI SISTEMA MAGNETICO



~~31,50€~~

**18,90€**

## FG 205

### LAMPADA PORTATILE A LED

DOTATA DI LED SUPERIORE, GANCIO ESTRAIBILE, BASE D'APPoggio MAGNETICA E ROTANTE FINO A 180°. INCLUSO CAVO DI RICARICA USB TIPO C.



**420 LUMEN**

~~85,00€~~

**49,90€**



LED SUPERIORE



GANCIO ESTRAIBILE

**FG 202**

**NEW**

**LAMPADA RICARICABILE A LED CON TSC SYSTEM**

LED DI PUNTAMENTO SUPERIORE  
TSC SYSTEM, TECNOLOGIA DI SPEGNIMENTO AUTOMATICO AL CONTATTO CON SUPERFICI  
CORPO IN ALLUMINIO ANODIZZATO  
DOPPIO MAGNETE, SULLA BASE E SUL RETRO  
GANCIO PER CINTURA  
CAVO USB TIPO C IN DOTAZIONE



**CE** **1.200 LUMEN**

~~55,00€~~ **32,90€**



LED DI PUNTAMENTO SUPERIORE



TSC SYSTEM

**FG 222/A**

**NEW**

**LAMPADA RICARICABILE A LED CON CASSE WIRELESS**

LED DI PUNTAMENTO SUPERIORE  
DOPPIA CASSA WIRELESS DA 5W  
GANCIO CON MAGNETI INTEGRATI, ESTRAIBILE ED ORIENTABILE A 180°, PER APPENDERE O APPOGGIARE LA LAMPADA  
GRADO DI RESISTENZA AD ACQUA E POLVERI IP54  
CAVO USB TIPO C IN DOTAZIONE



**CE** **500 LUMEN**

~~120,00€~~ **69,00€**



LED DI PUNTAMENTO SUPERIORE A 160 LUMEN



GANCIO ESTRAIBILE ED ORIENTABILE FINO A 180°

**FG 213/L480**

**LAMPADA DA TESTA A DOPPIO LED CON SENSORE ON/OFF CONTACTLESS**

**480 LUMEN**



**CE**

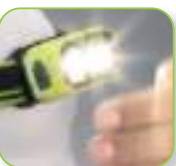

SENSORE ON/OFF CONTACTLESS



4 LIVELLI DI INCLINAZIONE

~~65,00€~~ **39,90€**

**FG 206**

**LAMPADA RICARICABILE A LED**

DESIGN SLIM  
MAGNETI SUL RETRO  
GANCIO PER APPENDERE LA LAMPADA  
GRADO DI PROTEZIONE IPX4  
CAVO MICRO USB IN DOTAZIONE



**CE**

**360 LUMEN**

~~55,00€~~ **32,90€**

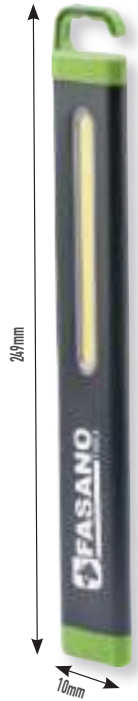

**FG 207**

**LAMPADA RICARICABILE A LED**

LED DI PUNTAMENTO SUPERIORE  
PIVOTANTE A 180°  
BASE MAGNETICA  
INDICATORE STATO DI CARICA  
GRADO DI RESISTENZA AD ACQUA E POLVERI IP54  
CAVO USB TIPO C IN DOTAZIONE



**300 LUMEN**



**CE**

~~65,00€~~ **35,90€**

**FG 207/B**

**NEW**

**LAMPADA RICARICABILE A LED**

LED DI PUNTAMENTO SUPERIORE  
PIVOTANTE A 180°  
BASE MAGNETICA  
INDICATORE STATO DI CARICA  
GRADO DI RESISTENZA AD ACQUA E POLVERI IP54  
CAVO USB TIPO C IN DOTAZIONE

**700 LUMEN**

CE



PIVOTANTE  
FINO A 180°



GIREVOLE  
FINO A 180°



~~98,00€~~ **59,90€**

**FG 210/A**

~~90,00€~~ **49,90€**

**MINI FARETTO PORTATILE A LED  
700 LUMEN**



90mm



CE



**1.200 LUMEN**

**FG 208**

~~230,00€~~ **119,00€**

**LAMPADA SOTTO COFANO  
RICARICABILE A LED**



CE

LUNGHEZZA REGOLABILE:  
1.300-2.060MM



LAMPADA PORTATILE  
INTEGRATA E REMOVIBILE



DOTATA DI SISTEMA  
MAGNETICO



360°

**1.200 LUMEN**

**FG 209**

~~265,00€~~ **149,00€**

**LAMPADA SOTTOCOFANO RICARICABILE  
A LED CON LENTE TRASPARENTE E SEMITRASPARENTE**



CE

1200 LUMEN



BRIGHT MODE

1100 LUMEN



COMFORTABLE MODE

600 LUMEN



SOFT MODE

INDICATORE DI CARICA



ESTRAIBILE 760MM



**FG 210/B**

~~85,00€~~ **49,90€**

**1200 LUMEN**

**LAMPADA A TUBO PORTATILE A LED**  
DOTATA DI LUCE SPOT SUPERIORE, BASE MAGNETICA,  
MODALITA' LUCE ROSSA D'EMERGENZA.  
INCLUSO CAVO DI RICARICA USB TIPO C.  
FUNZIONE DIMMER

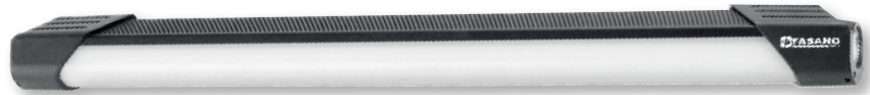

486mm



CE



LUCE FRONTALE BIANCA 1200 LUMEN  
LUCE FRONTALE ROSSA 50 LUMEN



SISTEMA DI AGGANCO  
MAGNETICO



RICARICA USB TIPO C



LUCE SPOT 400 LUMEN

**FG 211**

~~110,00€~~ **59,00€**

**600 LUMEN**

**LAMPADA RICARICABILE A LED**



385mm

CE

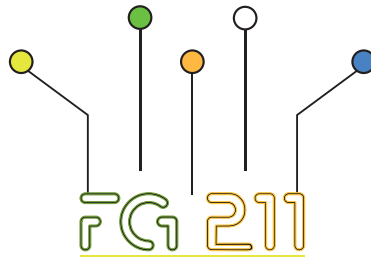

TOP LED DI  
PUNTAMENTO



ORIENTABILITÀ  
A 360°



REGOLATORE  
D'INTENSITÀ

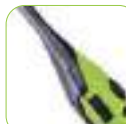

INDICATORE  
DI CARICA

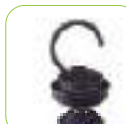

BASE MAGNETICA E  
GANCIO ESTRAIBILE

**FG 212**

~~78,00€~~ **39,90€**

**200 LUMEN**

**LAMPADA RICARICABILE A LED**



174mm



CE



IP20



MAGNETIC



MAX 5H



LI-ION  
BATTERY

FG 214/L600

~~85,00€~~ **39,00€**

TORCIA RICARICABILE A LED

**600 LUMEN**



CONO LUMINOSO  
REGOLABILE



PIASTRA DI SUPPORTO  
A PARETE IN DOTAZIONE

CE

FG 217

LAMPADA A 3 FARI LED,  
PORTATILE E RICARICABILE  
DOTATA DI SUPPORTO TELESCOPICO  
REGOLABILE IN ALTEZZA.  
INCLUSO CAVO DI RICARICA USB TIPO C.

**2.000 LUMEN**

~~250,00€~~ **149,00€**



GANCIO ESTRAIBILE



MAGNETE



H MAX: 1420mm - H MIN: 665mm

300mm



PANNELLO DI CONTROLLO

CE

FG 210/C

~~165,00€~~ **99,00€**

FARETTO DA LAVORO  
RICARICABILE A LED

FUNZIONE POWER BANK (OUTPUT MAX USB 5V 2A)  
SUPPORTO ORIENTABILE A 180°  
5 LIVELLI DI INDICAZIONE  
DELL'AUTONOMIA RESIDUA  
GRADO DI RESISTENZA AD ACQUA E POLVERI IP65  
GRADO DI RESISTENZA AGLI URTI IK07  
INDICE DI RESA CROMATICA CRI 70+  
CAVO USB TIPO C IN DOTAZIONE

NEW

**3.000 LUMEN**

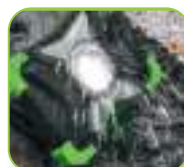

IP 65



FUNZIONE POWER BANK

CE

FG 222/B

~~350,00€~~ **189,00€**

FARO DA LAVORO RICARICABILE  
A LED CON CASSE WIRELESS

DOPPIA CASSA WIRELESS DA 10W  
FUNZIONE POWER BANK (OUTPUT MAX USB 5V 1A)  
CORPO ORIENTABILE A 140°  
5 LIVELLI DI INDICAZIONE DELL'AUTONOMIA RESIDUA  
GANCIO ESTRAIBILE E GIREVOLE  
INTEGRATO NELLA BASE  
GRADO DI RESISTENZA AD ACQUA E POLVERI IP65  
CARICABATTERIE IN DOTAZIONE

NEW

**4.000 LUMEN**



CASSE WIRELESS 10W



CORPO ORIENTABILE  
A 140°



CE

**FG 221**

~~340,00€~~ **199,00€**

**NEW**

**FARO DA LAVORO A DOPPIO  
CORPO ILLUMINANTE**

ROTAZIONE ORIZZONTALE DI 180° PER FARO: ILLUMINA EFFICACEMENTE

DIVERSE AREE DELL'AMBIENTE DI LAVORO

CORPO ORIENTABILE A 90°

BATTERIA AL LITIO ESTRAIBILE DA 14,8V

CON FUNZIONE POWER BANK (OUTPUT MAX USB 5V 2A)

5 LIVELLI DI INDICAZIONE DELL'AUTONOMIA RESIDUA

CARICABATTERIA IN DOTAZIONE

**4.500 LUMEN**



CE

CORPI ILLUMINANTI  
ORIENTABILI FINO A 180°



BATTERIA A LITIO  
CON FUNZIONE POWER BANK



**FG 224/L5200**

~~250,00€~~ **149,00€**

**NEW**

**FARO DA CANTIERE RICARICABILE A  
LED CON LENTE ANTIABBAGLIAMENTO**

SPECIALE LENTE OPACA CHE RIDUCE L'EFFETTO ABBAGLIAMENTO ED AUMENTA LA DIFFUSIONE DELLA LUCE

SUPPORTO ORIENTABILE A 180° ED AGGANCIABILE AL TREPPIEDI

3 LIVELLI DI INDICAZIONE DELL'AUTONOMIA RESIDUA

GRADO DI RESISTENZA AD ACQUA E POLVERI IP65

GRADO DI RESISTENZA AGLI URTI IK07

CARICABATTERIE IN DOTAZIONE

**5.200 LUMEN**



ORIENTABILE  
FINO A 180°



IP 65

CE

**FG 224/SU**

~~100,00€~~ **59,00€**

**NEW**

**TREPPIEDI PER FARO DA CANTIERE FG 224/L5200**

ALTEZZA MASSIMA 1,60 M



# LAMPADE PER CONTROLLO COLORE



## LAMPADE PER CONTROLLO COLORE

### SETTORE CARROZZERIA



**FG 234** ~~105,00€~~ **59,00€**

LAMPADA DA TESTA A DOPPIO LED  
AD ELEVATO INDICE DI RESA CROMATICA  
(CRI 96+) - 3 COLORI  
SENSORE ON/OFF CONTACTLESS



**COB LED - cri 96+  
3 COLORI**

**2700K 4500K 6500K**



SENSORE ON/OFF  
CONTACTLESS



4 LIVELLI DI INCLINAZIONE



50mm



**FG 235** ~~135,00€~~ **79,00€**

LAMPADA LED AD ELEVATO  
INDICE DI RESA CROMATICA  
(CRI 96+) - 3 COLORI



**COB LED - cri 96+  
3 COLORI**

**2700K 4500K 6500K**

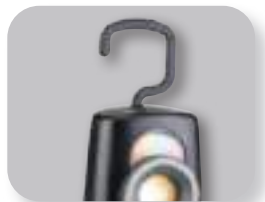

GANCIO ESTRAIBILE



LENTE SOSTITUIBILE



BASE MAGNETICA  
+ SUPER MAGNETE SUL RETRO



BASE DI RICARICA DA TAVOLO  
CON PRESA USB + CAVO MICRO USB  
DA 1 METRO IN DOTAZIONE



CE



ACCESSORIO TREPPIEDI  
NON INCLUSO

190mm



115mm



**FG 236**

~~335,00€~~

**199,00€**

**FARO LED RICARICABILE PER CONTROLLO COLORE AD ALTO INDICE DI RESA CROMATICA (CRI 96+)**

- 5 COLORI - 3 INTENSITA' 500 - 1000 - 2000 LUMEN

LED - cri 96+  
5 COLORI

2700K

3500K

4500K

5500K

6500K



PANNELLO DI CONTROLLO



CARICABATTERIE A SGANCIO RAPIDO CON CAVO DA 5M



180°



**FG 236/SU**

~~100,00€~~

**59,00€**

**TREPPIEDI PER FARO LED FG 236**

PESO NETTO: 1.098 gr

ALTEZZA: 476 MM (CHIUSO) - 1440 MM (APERTO)

NUMERO DI ESTENSIONI DEI PIEDI: 3

MASSIMO CARICO: 2 KG



**FG 225/SK1.5**

~~300,00€~~

**149,00€**

**AVVOLGITORE AUTOMATICO 15M 3GX1.5MM<sup>2</sup> CON PRESA SCHUKO**

LUNGHEZZA CAVO IN INGRESSO 1,20M

15m x 3G 1.5mm<sup>2</sup> 1000W

230V AC 2000W

**FG 225/SK2.5**

~~370,00€~~

**169,00€**

**AVVOLGITORE AUTOMATICO 15M 3GX2.5MM<sup>2</sup> CON PRESA SCHUKO**

LUNGHEZZA CAVO IN INGRESSO 1,20M

15m x 3G 2.5mm<sup>2</sup> 1600W

230V AC 3200W

CE

STAFFA A MURO ORIENTABILE A 360°



LIMITATORE DI RIENTRO PER ARRESTARE LA CORSA



SISTEMA DI BLOCCAGGIO A QUALSIASI LUNGHEZZA

# NUOVE BORSE PORTA UTENSILI

**CAPIENTI, COMODE E SUPER FUNZIONALI. CON LE NUOVE BORSE PORTA UTENSILI FASANO TOOLS PORTI IL TUO LAVORO OVUNQUE E TUTTO QUELLO CHE TI SERVE È SEMPRE CON TE!**

**6 NUOVI MODELLI** per ogni esigenza lavorativa. **Ampi scomparti separati e tasche multiple, laterali e frontali**, per riporre i tuoi utensili, differenziandone l'utilizzo e riprendere poi ciò che ti serve, senza perdere tempo. Non solo attrezzi! I nostri modelli di borse porta utensili sono ideati per trasportare anche oggetti di uso quotidiano come pc, chiavi, smartphone e tutto il necessario per lavorare fuori dagli ambienti di lavoro.



**NEW**



## TROLLEY, TRACOLLE, CESTELLI, BORSONI E ZAINI

Scegli lo **zaino con gli spallacci** imbottiti per avere le mani libere e conservare documenti e pc portatile. Con lo **zaino provvisto di manico telescopico** e ruote invece, puoi viaggiare anche in aereo e fare lunghi tragitti a piedi, senza fatica.

Prediligi un **cestello con copertura**, se preferisci il connubio tra la classica cassetta porta attrezzi ed un borsoni provvisto di tracolla.

Due **borsoni** con ampi scomparti interni e tasche esterne, ti permettono di separare gli oggetti di uso quotidiano dagli utensili da lavoro.

Puoi scegliere tra una struttura completamente rigida o una semi rigida.

Infine, con il **trolley**, trasporti con facilità utensili elettrici o manuali di peso maggiore, dove vuoi, senza sforzi.

Tutte realizzate in tessuto tecnico, le Borse Porta Utensili Fasano Tools sono la tua soluzione versatile ad ogni esigenza giornaliera. E che stile!



**FG 1450**
~~132,00€~~ **79,00€**
**BORSA PORTA UTENSILI IN TESSUTO**

TESSUTO TECNICO AD ELEVATA RESISTENZA  
 BASE SEMI RIGIDA CON RIALZI IN PLASTICA  
 AMPIO VANO CENTRALE  
 TASCHE MULTIPLE INTERNE ED ESTERNE  
 TASCA CHIUSA SUL RETRO  
 E DOPPIA TASCA CHIUSA FRONTALE CON PASSANTI  
 TRACCOLLA IMBOTTITA REGOLABILE

**NEW**

Dimensioni: 460x290x320mm

**FG 1452**
~~140,00€~~ **85,00€**
**CESTELLO PORTA UTENSILI IN TESSUTO CON COVER**

STRUTTURA RIGIDA IN TESSUTO TECNICO AD ELEVATA RESISTENZA  
 BASE IN PLASTICA RIGIDA  
 AMPIO SCOMPARTO APERTOCOVER  
 DI CHIUSURA CON VELCRO A SCOMPARSA  
 MANIGLIONE IN METALLO CON IMPUGNATURA IN GOMMA TASCHE  
 MULTIPLE E PASSANTI INTERNI ED ESTERNI  
 TASCA CHIUSA LATERALE E TASCA PORTA SEGNETTO FRONTALE  
 TRACCOLLA IMBOTTITA REGOLABILE

**NEW**

Dimensioni: 500x260x360mm

**FG 1454**
~~180,00€~~ **109,00€**
**BORSA PORTA UTENSILI IN TESSUTO**

STRUTTURA RIGIDA IN TESSUTO TECNICO AD ELEVATA RESISTENZA  
 BASE IN PLASTICA RIGIDA PER LA PROTEZIONE DEL CONTENUTO  
 DUE AMPI SCOMPARTI SEPARATI  
 TASCHE MULTIPLE E PASSANTI INTERNI ED ESTERNI  
 TASCHE CHIUSE SUL RETRO E SUL FRONTE  
 COMODA MANIGLIA E TRACCOLLA IMBOTTITA REGOLABILE

**NEW**

Dimensioni: 450x250x330mm

**FG 1456**
~~230,00€~~ **139,00€**
**TROLLEY PORTAUTENSILI IN TESSUTO**

TESSUTO TECNICO AD ELEVATA RESISTENZA  
 MANICO TELESCOPICO E 2 RUOTE RESISTENTI  
 STRUTTURA RIGIDA CON AMPIO SCOMPARTO INTERNO  
 TASCHE INTERNE ED ESTERNE PER UN'OTTIMALE  
 ORGANIZZAZIONE DELLO SPAZIO  
 2 TASCHE ESTERNE FRONTALI CHIUSE

**NEW**

Dimensioni: 470x330x270mm

**FG 1460**
~~150,00€~~ **89,00€**
**ZAINO PORTAUTENSILI IN TESSUTO**

TESSUTO TECNICO AD ELEVATA RESISTENZA  
 BASE IN PLASTICA RIGIDA, DOPPIO VANO INTERNO,  
 PORTA UTENSILI E PORTA PC E DOCUMENTI  
 TASCHE MULTIPLE LATERALI E FRONTALI,  
 INTERNE ED ESTERNE  
 SCHIENALE ERGONOMICO IMBOTTITO  
 SPALLACCI IMBOTTITI

**NEW**

Dimensioni: 310x220x460mm

**FG 1465**
~~200,00€~~ **119,00€**
**ZAINO PORTAUTENSILI IN TESSUTO CON RUOTE**

DIMENSIONI BAGAGLIO A MANO  
 TESSUTO TECNICO AD ELEVATA RESISTENZA  
 MANICO TELESCOPICO A SCOMPARSA  
 RUOTE INTEGRATE CON COVER RICHIUDIBILE  
 DOPPIO VANO INTERNO,  
 TASCHE MULTIPLE LATERALI E FRONTALI,  
 SCHIENALE ERGONOMICO IMBOTTITO  
 SPALLACCI IMBOTTITI

**NEW**

Dimensioni: 350x200x520mm



**FG 111/AS104**

**CASSETTA PORTA-UTENSILI FG 111/C CON 5 SCOMPARTI CON ASSORTIMENTO 104 UTENSILI**

~~863,50€~~ **299,00€**



**FG 111/A**

~~60,80€~~ **32,90€**

**CASSETTA PORTA-UTENSILI A 3 SCOMPARTI**

- PREDISPOSIZIONE PER LUCCHETTO
- DIVISORIO SCOMPARTO SUPERIORE
- STRUTTURA IN LAMIERA



**CASSETTA PORTA-UTENSILI A 5 SCOMPARTI**

- PREDISPOSIZIONE PER LUCCHETTO
- DIVISORIO SCOMPARTO SUPERIORE
- STRUTTURA IN LAMIERA



CODICE	DIMENSIONE	LISTINO	€/PROMO
FG 111/B	430x200x200mm	72,00	39,90
FG 111/C	530x200x200mm	88,00	49,90

**FG 113/A**

**BAULE PORTA UTENSILI**

DOTATO DI MANIGLIONI LATERALI RICHIUDIBILI  
PREDISPOSIZIONE PER LUCCHETTO DI CHIUSURA  
STRUTTURA IN LAMIERA D'ACCIAIO 0.8MM

DIMENSIONI: 520X290X290mm

**NEW**



~~175,00€~~ **99,00€**

**FG 113/B**

**BAULE PORTA UTENSILI**

DOTATO DI MANIGLIONI LATERALI RICHIUDIBILI  
PREDISPOSIZIONE PER LUCCHETTO DI CHIUSURA  
STRUTTURA IN LAMIERA D'ACCIAIO 0.8MM

DIMENSIONI: 650X350X350mm

**NEW**



~~210,00€~~ **119,00€**

**FG 113/C**

**BAULE PORTA UTENSILI**

DOTATO DI MANIGLIONI LATERALI RICHIUDIBILI  
PREDISPOSIZIONE PER LUCCHETTO DI CHIUSURA  
STRUTTURA IN LAMIERA D'ACCIAIO 0.8MM

DIMENSIONI: 850X350X350mm

**NEW**



~~250,00€~~ **149,00€**

**FG 113/D**

**BAULE PORTA UTENSILI**

DOTATO DI MANIGLIONI LATERALI RICHIUDIBILI  
PREDISPOSIZIONE PER LUCCHETTO DI CHIUSURA  
STRUTTURA IN LAMIERA D'ACCIAIO 0.8MM

DIMENSIONI: 1000X400X450mm

**NEW**



~~300,00€~~ **184,00€**



# BORSE DA LAVORO

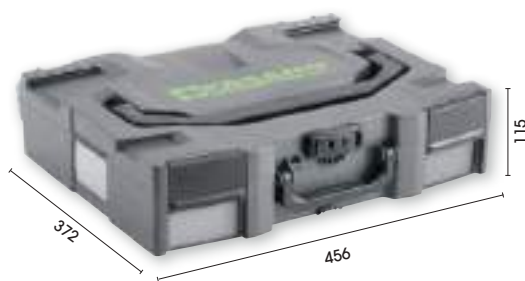

**FG 1425**

~~102,00€~~ **49,00€**

**VALIGIA PORTAUTENSILI IN ABS**  
DIMENSIONE: 456X372X115MM  
PESO: 2.1KG



**FG 1426**

~~120,00€~~ **59,00€**

**VALIGIA PORTAUTENSILI IN ABS**  
DIMENSIONE: 456X372X155MM  
PESO: 2.4KG



**FG 1427**

~~170,00€~~ **89,00€**

**VALIGIA PORTAUTENSILI IN ABS**  
DIMENSIONE: 456X372X262MM  
PESO: 3KG



**FG 1434**

**VALIGIA PORTAUTENSILI IN ABS  
DOTATA DI BOX INTERNI**  
DIMENSIONE: 456X372X115MM  
PESO: 3.2KG

~~145,00€~~ **69,00€**



**FG 1433**

**CARRELLO PIEGHEVOLE  
RICHIUDIBILE**

STRUTTURA IN FERRO  
BASE IN ALLUMINIO  
PESO: 6KG - PORTATA: 100KG  
Ø RUOTE: 180MM  
CHIUSO: 70X485X835MM  
BASE: 480X350MM

~~190,00€~~ **79,00€**



**FG 109/L3**

**CARRELLO PORTA OGGETTI  
PIEGHEVOLE**

SISTEMA DI BLOCCAGGIO  
PESO: 11KG - PORTATA: 300KG  
DIMENSIONI:  
945X485X810mm

~~280,00€~~ **99,00€**

**FG 114/L2**

~~65,00€~~ **29,90€**

**VALIGIA PORTA UTENSILI IN ABS**

- 2 SCOMPARTI SOVRAPPONIBILI E SEPARABILI
- FINESTRE ANTERIORI TRASPARENTI
- MANIGLIA ERGONOMICA ORIENTABILE E REGOLABILE



**FG 114/L3**

~~110,00€~~ **39,90€**

**CASSETTA PORTA UTENSILI  
A 3 RIPIANI**

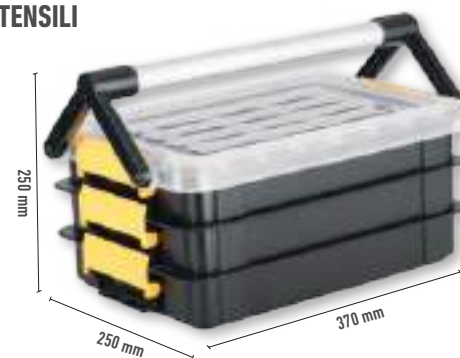



FG 116/A

~~390,00€~~

**199,00€**

## VALIGIA PORTA-UTENSILI IN POLIPROPILENE AD ALTA RESISTENZA

DUE SERRATURE LATERALI CON CHIAVESISTEMA PORTA UTENSILI AD ELASTICO DOTATA DI PIEDINI D'APPOGGIO 3 CERNIERE POSTERIORI IN METALLO FONDO CON DIVISORI AMOVIBILI DOTATA DI VANO TARGHETTA PORTA NOME



DIMENSIONI: 465X215X352mm

FG 117/A

~~450,00€~~

**229,00€**

## VALIGIA PORTA-UTENSILI IN ABS TERMOFORMATO

- 2 SERRATURE LATERALI CON CHIAVE
- SISTEMA PORTA UTENSILI A TASCHE
- DOTATA DI PIEDI DDI APPOGGIO
- FONDO TERMOFORMATO
- SISTEMA TROLLEY INTEGRATO

DIMENSIONI: 453X332X197mm



**FG 118/AS56**
~~780,90€~~ **429,00€**
**ASSORTIMENTO 56 UTENSILI  
PER ELETTROTECNICA**

FG 22E/2.5x75	GIRAVITE ISOLATO A TAGLIO 2.5x75 mm
FG 22E/3x100	GIRAVITE ISOLATO A TAGLIO 3x100 mm
FG 22E/4x100	GIRAVITE ISOLATO A TAGLIO 4x100 mm
FG 22E/5.5x125	GIRAVITE ISOLATO A TAGLIO 5.5x125 mm
FG 22E/6.5x150	GIRAVITE ISOLATO A TAGLIO 6.5x150 mm
FG 22E/PH0x60	GIRAVITE ISOLATO A CROCE PH0x60
FG 22E/PH1x80	GIRAVITE ISOLATO A CROCE PH1x80
FG 22E/PH2x100	GIRAVITE ISOLATO A CROCE PH2x100
FG 129/C4	CACCIASPINA 4mm
FG 129/C5	CACCIASPINA 5mm
FG 126/SL1	SCALPELLO LUNGO PER ELETTRICISTI
FG 126/SL2	SCALPELLO LUNGO PER ELETTRICISTI
FG 127/P1	SCALPELLO PIATTO mm26x240L
FG 602/SP9	SET 9 CHIAVI A DOPPIA FORCHETTA 6x7-21x23mm
FG 139/C	SET 10 CHIAVI MASCHIO A L ESAGONALE LUNGO
FG 96/SS36	SALDATORE A STILO 30/60W
FG 22/FX5	GIRAVITE A BUSSOLA 5mm
FG 22/FX6	GIRAVITE A BUSSOLA 6mm
FG 22/FX7	GIRAVITE A BUSSOLA 7mm
FG 22/FX8	GIRAVITE A BUSSOLA 8mm
FG 22/FX10	GIRAVITE A BUSSOLA 10mm
FG 22/FX13	GIRAVITE A BUSSOLA 13mm
FG 58/IS250	PINZA ISOLATA REGOLABILE A CERNIERA
FG 59/IS180	PINZA UNIVERSALE ISOLATA - 180mm
FG 61/IS200	PINZA ISOLATA BECCHI MEZZOTONDI -200mm
FG 63/IS160	TRONCHESE DIAGONALE ISOLATA -160mm
FG 68IS/160	PINZA SPELLAFILI ISOLATA -160mm
FG 49	FORBICE PER ELETTRICISTA
FG 48/IS	CUTTER ISOLATO PER ELETTRICISTI
FG 68/S1	PINZA X CAPICORDA NON-ISOLATI
FG 22/CF250	GIRAVITE CERCAFASE 110-250V
FG 68/CS2	SPELLAFILI 8-28mm
FG 48/L	CUTTER PROFESSIONALE A LAMA LUNGA
FG 136/L35	MAZZUOLA ANTI-RIMBALZO -35gr
FG 132/300	MARTELLO TEDESCO CON MANICO IN RESINA -300gr
FG 81/PT2	PUNTE A TRACCIARE
FG 44/MT5	FLESSOMETRO IN NYLON 5Mx25mm
FG 50/MS	MINISEGHETTO CON LAMA
FG 497/OP2	OLIATORE A PRESSIONE CANNUCIA OTTONE 80cc

**FG 118/AS75**
~~592,30€~~ **349,00€**
**ASSORTIMENTO 75 UTENSILI  
PER MANUTENZIONE GENERALE**

FG 602/SP9	SET 9 CHIAVI A DOPPIA FORCHETTA 6x7-21x23mm
FG 22/2.5x75	GIRAVITE A TAGLIO 2.5x75mm
FG 22/3.5x100	GIRAVITE A TAGLIO 3.5x100mm
FG 22/4x150	GIRAVITE A TAGLIO 4x150mm
FG 22/6.5x150	GIRAVITE A TAGLIO 6.5x150mm
FG 22/8x150	GIRAVITE A TAGLIO 8x150mm
FG 22/PH0x60	GIRAVITE A CROCE PH0x60
FG 22/PH1x80	GIRAVITE A CROCE PH1x80
FG 22/PH2x150	GIRAVITE A CROCE PH2x150
FG 58/B240	PINZA REGOLABILE CERNIERA 240mm
FG 59SR/180	PINZA UNIVERSALE -180mm
FG 61SR/160	PINZA BECCHI MEZZOTONDI -160mm
FG 63SR/160	TRONCHESE TAGLIANTI DIAGONALI -160mm
FG 49/HE250	FORBICE MULTIUSO MOD. PESANTE 250mm
FG 69/CJ250	PINZA AUTOBLOCCANTE 250mm
FG 35/B4	CHIAVE A RULLINO mm250
FG 132/500	MARTELLO TEDESCO CON MANICO IN RESINA -500gr
FG 49	FORBICE PER ELETTRICISTA
FG 44/MT5	FLESSOMETRO IN NYLON 5Mx25mm
FG 80/8AP	LIMA PIATTA TAGLIO MEZZODOLCE 200mm
FG 81/MS	MATITA X FALEGNAME
FG 48/L	CUTTER PROFESSIONALE A LAMA LUNGA
FG 79/SP3	SPAZZOLA FILI RIGIDI IN ACCIAIO
FG 139/C	SET 10 CHIAVI MASCHIO A L ESAGONALE LUNGO
FG 85/S31	SET 31 INSERTI + ADATTATORE PORTA INSERTI
FG 94/300	LIVELLA MAGNETICA 300mm
FG 88/P14	GIRAVITE PORTA INSERTI 1/4"
FG 80/8AQ	LIMA QUADRA TAGLIO MEZZODOLCE 200mm



# ESTRATTORI



FG 162/S3

~~366,00€~~ 219,00€

SET 3 ESTRATTORI A 2 GRIFFE

27-90MM, 27-135MM, 35-155MM



+



FG 163/S2B

ESTRATTORE A 3 GRIFFE PER PRESA ESTERNA + GRIFFE PER PRESA INTERNA

- APERTURA MAX PER PRESA ESTERNA: 7-140MM

- APERTURA MAX PER PRESA INTERNA: 50-70MM

~~263,00€~~ 155,00€

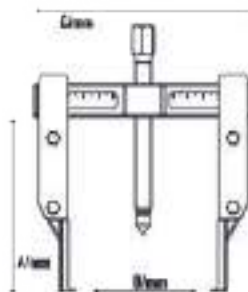

ESTRATTORE UNIVERSALE A 2 GRIFFE SOTTILI

GRIFFE INTERCAMBIABILI SUPER SOTTILI DA 2MM IN ACCIAIO AL CROMO VANADIO

PRESA INTERNA ED ESTERNA VITE IN ACCIAIO AL CROMO VANADIO

CODICE	A/mm	B/mm	C/mm	LISTINO	€/PROMO
FG 168/EF1	110	140	186	319,50	189,00
FG 168/EF2	195	140	186	330,00	199,00

ESTRATTORE UNIVERSALE A 2 GRIFFE

MODELLO A FORBICE

GRIFFE REGOLABILI IN ACCIAIO AL CROMO VANADIO

PRESA ESTERNA

VITE IN ACCIAIO AL CROMO VANADIO

CODICE	A/mm	LISTINO	€/PROMO
FG 162/FR1	90	149,50	89,90
FG 162/FR2	125	196,00	119,00
FG 162/FR3	125	237,00	139,00



**ESTRATTORE AUTOCENTRANTE A 3 GRIFFE**

- POSSIBILITÀ DI 4 POSIZIONI DIFFERENTI
- PRESA ESTERNA
- MECCANISMO AUTOCENTRANTE
- GRIFFE CON APERTURA PER CONSENTIRE UNA MIGLIOR PRESA SU BULLONI SPECIALI



CODICE	CAPACITÀ	APERTURA	AXBXC/mm	HxL/mm	LISTINO	€/PROMO
FG 160/1	2 TON	20 - 115MM	8X6X15	80X120	108,50	65,00
FG 160/2	5 TON	30 - 240MM	11X10X25	160X250	235,00	139,00
FG 160/3	10 TON	40 - 380MM	14X10X29	230X280	420,00	249,00

**ESTRATTORE MANUALE DI GRANDE POTENZA A 3 GRIFFE**

- PRESA ESTERNA
- LE LEVE DI SUPPORTO AD OGNI GRIFFA MOLTIPLICANO LA POTENZA GARANTENDO LIVELLI DI FORZA ELEVATI



CODICE	CAPACITÀ	APERTURA	AXBXC/mm	HxL/mm	LISTINO	€/PROMO
FG 161/1	2 TON	28 - 112MM	8X6X15	80X120	124,00	75,00
FG 161/2	5 TON	40 - 243MM	11X10X25	160X250	250,00	149,00
FG 161/3	10 TON	46 - 370MM	14X10X29	230X280	474,00	289,00

**SET ESTRATTORI PER DADI DESTORSI DANNEGGIATI CON ATTACCO 1/2"**

FORNITO SU SUPPORTO IN ABS APPENDIBILE CON GANCI A CLIP E MECCANISMO FINECORSA ANTICADUTA



CODICE	CONTENUTO MM	LISTINO	€/PROMO
FG 168A/S5	22, 24, 27, 30, 32	110,00	65,00
FG 168A/S13	8, 9, 10, 11, 12, 13, 14, 15, 16, 17, 18, 19, 21	210,00	129,00

**FG 168EP/S5**
**SET 5 ESTRATTORI CONICI PER VITI E PRIGIONIERI SPEZZATI**

- INSERIMENTO A PERCUSSIONE



~~33,00€~~ **19,90€**

**FG 182/S5B**

~~475,00€~~ **279,00€**

**SET ESPANSORI A SETTORE PER INTERNI CON ACCESSORI**

CONTENUTO: FG 182/EG1 - FG 182/ES1  
FG 182/ES2 - FG 182/ES3 - FG 182/ES4 - FG 182/ES5



- DOTATO DI GUIDE PER INTERNO ED ESTERNO E PUNTE PER FORARE  
- PER VITI/BULLONI CON DIAMETRO 6-16MM

**FG 168/S25**

~~144,00€~~ **79,00€**

**SET ESTRATTORI PER VITI E PRIGIONIERI SPEZZATI**

**FG 182/S14**

~~238,00€~~ **145,00€**

**SET ESTRATTORI PER CUSCINETTI CON FALSE SFERE**

- ØMM: 5, 6, 8, 9, 11, 12,5



CE



COPPIA DI SPUNTO



MARTELLO SINGOLO

1.200	(746 Nm)	(610 Nm)	136 L/min	9.500 RPM	6.2 Bar
-------	----------	----------	-----------	-----------	---------

FGA 307

~~250,00€~~ 149,00€

AVVITATORE AD IMPULSI-1/2"



CE



COPPIA DI SPUNTO



MARTELLO DOPPIO

1.900	(1.085 Nm)	(746 Nm)	151 L/min	7.300 RPM	6.2 Bar
-------	------------	----------	-----------	-----------	---------

FGA 309

~~300,00€~~ 179,00€

AVVITATORE AD IMPULSI-1/2"



CE



COPPIA  
DI SPUNTO



MARTELLLO  
DOPPIO



FGA 312

~~380,00€~~ **199,00€**

AVVITATORE AD IMPULSI-1/2"



CE



MARTELLLO  
DOPPIO



FGA 302

~~240,00€~~ **125,00€**

AVVITATORE AD IMPULSI-1/2"



CE



Coppia  
di spunto



Martello  
singolo



FGA 307/AN

~~340,00€~~ **179,00€**

AVVITATORE ANGOLARE  
AD IMPULSI-1/2"



FGA 309/S4

SET AVVITATORE 1/2" FGA 309  
+ 03 BUSSOLE RINFORZATE  
X CERCHI IN LEGA LEGGERA

~~385,00€~~ **235,00€**



FGA 309/S10

SET AVVITATORE 1/2" FGA 309  
+ 9 BUSSOLE RINFORZATE  
CORTE 1/2"

~~395,00€~~ **239,00€**



# UTENSILI PNEUMATICI

**FGA 316/L**

~~830,00€~~ **489,00€**

AVVITATORE AD IMPULSI - 3/4"  
AD ALBERO LUNGO 6"

**FGA 316**

~~760,00€~~ **439,00€**

AVVITATORE AD IMPULSI-3/4"



MARTELLINO DOPPIO

CE



**FGA 319/L**

~~1.250,00€~~ **659,00€**

AVVITATORE AD IMPULSI 1"  
AD ALBERO LUNGO 6"

**FGA 319**

~~1.150,00€~~ **599,00€**

AVVITATORE AD IMPULSI -1"



PIN-LESS

CE



**FGA 321/B**

~~1.100,00€~~ **579,00€**

AVVITATORE AD IMPULSI 1"  
AD ALBERO LUNGO 6"

**FGA 321**

~~1.050,00€~~ **559,00€**

AVVITATORE AD IMPULSI -1"



MARTELLINO DOPPIO

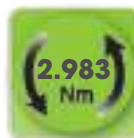

CE





PIN-LESS



**FGA 321/C**

AVVITATORE AD IMPULSI 1"  
AD ALBERO LUNGO 6"

~~1.220,00€~~ **629,00€**



IDEALE PER UTILIZZI INTENSIVI



**FGA 290**

CRICCHETTO REVERSIBILE 1/4"

SISTEMA DI REVERSIBILITÀ INTEGRATA SULLA TESTA  
SISTEMA DI AZIONAMENTO A PINZA  
ATTACCO ARIA 1/4" GAS  
Ø INTERNO TUBO ARIA 10MM (3/8")



~~192,00€~~ **115,00€**



COPPIA  
TORCENTE

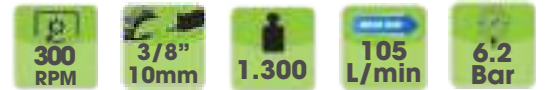

**FGA 292/B**

CRICCHETTO REVERSIBILE 1/2"

~~215,00€~~ **129,00€**



**FGA 390**

PISTOLA DI  
GONFIAGGIO



~~150,00€~~ **85,00€**

- OMOLOGATA CEE

- CORPO IN ALLUMINIO NICHELATO
- RIVESTIMENTO IN GOMMA ANTIOLIO
- MANOMETRO Ø80 (0-10BAR)
- PROTEZIONE SOVRAPRESSIONI
- LEVA A DUE POSIZIONI SCARICO/GONFIAGGIO
- LUNGHEZZA TUBO: 500MM



**FGA 322**

LEVIGATRICE  
PER PNEUMATICI



FGA 322/R2: MOLA DI  
RICAMBIO 30,00€

~~140,00€~~ **85,00€**



# UTENSILI PNEUMATICI

**FGA 332**



TRAPANO REVERSIBILE CON  
MANDRINO AUTOSERRANTE 1-10MM

0.45 Hp	1.800 RPM	900
113 L/min	1/4" 6mm	6.2 Bar



~~145,00€~~ **89,00€**

**FGA 333**



TRAPANO REVERSIBILE CON  
MANDRINO AUTOSERRANTE 1-13MM

0.45 Hp	700 RPM	1.300
113 L/min	1/4" 6mm	6.2 Bar



~~185,00€~~ **109,00€**

**FGA 333/AC**

~~210,00€~~ **129,00€**

TRAPANO REVERSIBILE CON  
MANDRINO IN ACCIAIO 1-13MM

0.45 Hp	700 RPM	1.200
113 L/min	1/4" 6mm	6.2 Bar



**FGA 332/AN**

~~180,00€~~ **109,00€**

TRAPANO ANGOLARE  
MANDRINO AUTOSERRANTE  
1-10MM

0.45 Hp	1.800 RPM	900
60 L/min	1/4" 6mm	6.2 Bar



**FGA 340**

~~295,00€~~ **169,00€**

- ø orbita: 5.0mm  
- platorello 15 fori

152mm	11.000 RPM	900
45.2 L/min	1/2" 13mm	6.2 Bar



150mm	11.000 RPM	800
46 L/min	1/4" 6mm	6.2 Bar

**FGA 340/B**

~~295,00€~~ **169,00€**

- ø orbita: 2.5mm  
- platorello 15 fori

**FGA 342/B**

LEVIGATRICE  
ROTO-ORBITALE

- ø orbita: 2.5mm  
- platorello 3 fori

75mm	11.000 RPM	500
46 L/min	1/4" 6mm	6.2 Bar



~~285,00€~~ **169,00€**

**FGA 337**

CE

**LEVIGATRICE PNEUMATICA  
PER RIMOZIONE RESIDUI GOMMOSI**



~~125,00€~~ **75,00€**

**FGA 330**

CE

**SEGHETTO ALTERNATIVO**



~~295,00€~~ **169,00€**

**FGA 339**

~~355,00€~~ **199,00€**

**LEVIGATRICE ANGOLARE - Ø DISCO: 115MM**

Capacità disco: 115mm  
Sistema di regolazione velocità a pinza  
Attacco aria 1/4" gas  
Ø interno tubo aria 10mm (3/8")



**FGA 346/B**

~~220,00€~~ **129,00€**

**MICROSMERIGLIATRICE ASSIALE**

- Capacità pinza: 3mm



CE

**FGA 335**

**RIVETTATRICE PNEUMATICA**

- 4 testine intercambiabili

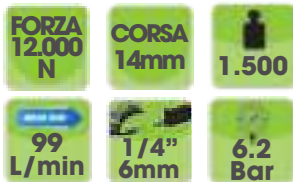

~~210,00€~~ **115,00€**

**FGA 336**

**RIVETTATRICE PNEUMATICA**

- 4 testine intercambiabili

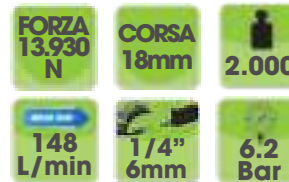

~~600,00€~~ **359,00€**



# UTENSILI PNEUMATICI

**FGA 338**

SMERIGLIATRICE DIRITTA A PINZA

~~125,00€~~ **75,00€**



0.50 Hp	22.000 RPM	600
99 L/min	1/4" 6mm	6.2 Bar

CE

## LAME ROTORE IN KEVLAR

**FGA 334**

SMERIGLIATRICE DIRITTA A PINZA

~~145,00€~~ **89,00€**



0.35 Hp	25.000 RPM	400
74 L/min	1/4" 6mm	6.2 Bar

CE

**FGA 338/B**

SMERIGLIATRICE DIRITTA A PINZA A BASSA VELOCITA'

~~160,00€~~ **95,00€**



0.45 Hp	7.600 RPM	600
74 L/min	1/4" 6mm	6.2 Bar

CE

**FGA 334/AN115**

SMERIGLIATRICE ANGOLARE A PINZA - INCLINAZIONE 115°

~~185,00€~~ **109,00€**



0.35 Hp	22.000 RPM	600
74 L/min	1/4" 6mm	6.2 Bar

CE

**FGA 338/AN**

SMERIGLIATRICE ANGOLARE A PINZA

~~170,00€~~ **99,00€**



0.45 Hp	18.000 RPM	700
60 L/min	1/4" 6mm	6.2 Bar

CE

**FGA 334/AN**

SMERIGLIATRICE ANGOLARE A PINZA

~~185,00€~~ **109,00€**



0.35 Hp	22.000 RPM	500
60 L/min	1/4" 6mm	6.2 Bar

CE

**FGA 338/L**

SMERIGLIATRICE DIRITTA A PINZA AD ALBERO LUNGO

~~165,00€~~ **99,00€**



0.45 Hp	22.000 RPM	800
60 L/min	1/4" 6mm	6.2 Bar

CE

**FGA 334/L**

SMERIGLIATRICE DIRITTA A PINZA AD ALBERO LUNGO

~~185,00€~~ **109,00€**



0.35 Hp	25.000 RPM	700
74 L/min	1/4" 6mm	6.2 Bar

CE

**FGA 343/N10** **CE**

**LEVIGATRICE A NASTRO**  
- 10x330mm



~~220,00€~~ **135,00€**

**FGA 342**

**LEVIGATRICE ORBITALE**  
- ø orbita: 2mm



~~220,00€~~ **129,00€**

**FGA 343/N20** **CE**

**LEVIGATRICE A NASTRO**  
- 20X520MM



~~285,00€~~ **175,00€**

**FGA 341**

**LEVIGATRICE MULTI-FUNZIONE**

Sistema di aspirazione integrato nel corpo macchina  
Supporto laterale girevole a 180°  
Attacco aria 1/4" gas  
Ø interno tubo aria 10mm (3/8")



~~650,00€~~ **399,00€**

**CE**



**TUBO IN POLIURETANO RETINATO**  
**STAFFA A MURO ORIENTABILE A 360°**

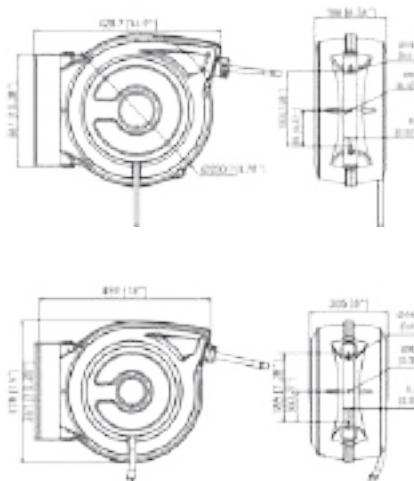

**FGA 383/AR15**

**AVVOLGITUBO AUTOMATICO**  
**PER ARIA COMPRESSA -15MT.**  
- ø tubo interno: 8mm

~~270,00€~~ **139,00€**

**FGA 385/AR15**

**AVVOLGITUBO AUTOMATICO**  
**PER ARIA COMPRESSA -15MT.**  
- ø tubo interno: 10mm

~~360,00€~~ **179,00€**

**Guida di scorrimento**  
**automatico**



**Sistema di bloccaggio**  
**a qualsiasi lunghezza**



**Riavvolgimento a**  
**velocità controllata**





# CARRELLI E BANCHI DA LAVORO



**5 VARIANTI COLORE  
PER ARREDARE I TUOI SPAZI**

RAL  
7021

RAL  
9016

RAL  
6018

RAL  
5002

RAL  
3001



**MADE IN ITALY**



**SCEGLI TRA I MODELLI A DISPOSIZIONE  
QUELLO PIU' ADATTO ALLE TUE NECESSITA'**



**SIMPLE TOOL TROLLEY**



**EXTENDED TOOL TROLLEY**



**KG 800** PORTATA STATICA

**MADE IN ITALY**

**FG 100 BI COLOR**

**NEW**

**CARRELLO PORTA UTENSILI BICOLOR A 7 CASSETTI MOD. FG 100**

**CARATTERISTICHE TECNICHE:**

- Guide telescopiche con sistema di aggancio automatico
- 4 ruote in gomma vulcanizzata Ø125mm
- ripiano superiore in ABS con maniglione integrato
- chiusura laterale centralizzata
- porta flaconi laterali di serie

CODICE	RAL	€/LISTINO	€/PROMO
FG 100VD/7T	6018+7021	1.350,00	699,00
FG 100VW/7T	6018+9016	1.350,00	699,00
FG 100BW/7T	5002+9016	1.350,00	699,00
FG 100BD/7T	5002+7021	1.350,00	699,00
FG 100RD/7T	3001+7021	1.350,00	699,00
FG 100RY/7T	3001+1018	1.350,00	699,00
FG 100CW/7T	5012+9016	1.350,00	699,00
FG 100MA/7T	3004+9016	1.350,00	699,00
FG 100RW/7T	3001+9016	1.350,00	699,00
FG 100RB/7T	3001+5002	1.350,00	699,00
FG 100DP/7T	7021+3015	1.350,00	699,00
FG 100DW/7T	7021+9016	1.350,00	699,00
FG 100BY/7T	5002+1018	1.350,00	699,00
FG 100GW/7T	3004+9016	1.350,00	699,00



**KG 800** PORTATA STATICA

**MADE IN ITALY**

**FG 100**

**CARRELLO PORTA UTENSILI MOD. FG 100**

**CARATTERISTICHE TECNICHE:**

- Guide telescopiche con sistema di aggancio automatico
- 4 ruote in gomma vulcanizzata Ø125mm
- ripiano superiore in ABS con maniglione integrato
- chiusura laterale centralizzata
- porta flaconi laterali di serie



**SISTEMA DI CHIUSURA LATERALE**



**RIPIANO SUPERIORE IN ABS**



**CASSETTO CON APERTURA COMPLETA**



CODICE	CASSETTI	€/LISTINO	€/PROMO
FG 100V/5T	5 CASSETTI	1.000,00	519,00
FG 100V/6T	6 CASSETTI	1.050,00	539,00
FG 100V/7T	7 CASSETTI	1.100,00	559,00

# CARRELLI E BANCHI DA LAVORO



## FG 102

### CARRELLO PORTA UTENSILI MOD. FG 102

#### CARATTERISTICHE TECNICHE:

- Guide telescopiche con sistema di aggancio automatico
- 4 ruote in gomma vulcanizzata Ø125mm
- maniglione laterale in acciaio
- chiusura centralizzata
- cassetti dotati di tappetino interno in gomma



4 RUOTE Ø125  
(2 GIREVOLI-2 FISSE)



TOP IN GOMMA



MANIGLIONE IN ACCIAIO



**KG 800**  
PORTATA  
STATICA

MADE IN ITALY

CODICE	Cassetti	€/Listino	€/PROMO
FG 102V/5G	5 CASSETTI	960,00	469,00
FG 102V/6G	6 CASSETTI	1.030,00	499,00
FG 102V/7G	7 CASSETTI	1.100,00	529,00
FG 102V/8G	8 CASSETTI	1.150,00	559,00



## FG 104

### CARRELLO PORTA UTENSILI MOD. FG 104

#### CARATTERISTICHE TECNICHE:

- Guide telescopiche con sistema di aggancio automatico
- 4 ruote in gomma vulcanizzata Ø125mm
- maniglione laterale in acciaio
- chiusura centralizzata
- cassetti dotati di tappetino interno in gomma



MANIGLIONE IN ACCIAIO INOX



CHIUSURA CENTRALIZZATA



**KG 1000**  
PORTATA  
STATICA

MADE IN ITALY

CODICE	CASSETTI	€/LISTINO	€/PROMO
FG 104V/6G	6 CASSETTI	1.250,00	579,00
FG 104V/7G	7 CASSETTI	1.350,00	599,00



**FG 105**

**CARRELLO PORTA UTENSILI MOD. FG 105**

**CARATTERISTICHE TECNICHE:**

- Guide telescopiche con sistema di aggancio automatico
- 4 ruote in gomma vulcanizzata Ø125mm
- maniglione laterale in acciaio
- chiusura centralizzata
- cassetti dotati di tappetino interno in gomma



**RIPIANI INTERNI REGOLABILI**



**ANTINA APRIBILE A 90°, DOTATA DI SERRATURA**

**FG 105 XL**

**MADE IN ITALY**



CODICE				CASSETTI	€/LISTINO	€/PROMO
FG 105V/5G	FG 105B/5G	FG 105R/5G	FG 105D/5G	5 CASSETTI	<del>1.300,00</del>	<b>689,00</b>
FG 105V/6G	FG 105B/6G	FG 105R/6G	FG 105D/6G	6 CASSETTI	<del>1.400,00</del>	<b>739,00</b>
FG 105V/7G	FG 105B/7G	FG 105R/7G	FG 105D/7G	7 CASSETTI	<del>1.450,00</del>	<b>769,00</b>



**FG 109**

**CARRELLO PORTA UTENSILI MOD. FG 109 CON APPENDICE LATERALE**



**RIPIANI IN GOMMA**



**RIPIANI INTERNI AMOVIBILI E REGOLABILI**

**FG 109 XL**

**MADE IN ITALY**



CODICE				CASSETTI	€/LISTINO	€/PROMO
FG 109V/6G	FG 109B/6G	FG 109R/6G	FG 109D/6G	6 CASSETTI	<del>1.600,00</del>	<b>849,00</b>
FG 109V/7G	FG 109B/7G	FG 109R/7G	FG 109D/7G	7 CASSETTI	<del>1.650,00</del>	<b>879,00</b>

# CARRELLI E BANCHI DA LAVORO



**KG 500** PORTATA STATICA

**FG 101**

**CARRELLO PORTA UTENSILI MOD. FG 101**

**CARATTERISTICHE TECNICHE:**

- Guide telescopiche con sistema di aggancio automatico
- 4 ruote in gomma vulcanizzata Ø125mm (2 fisse e 2 girevoli - 1 con freno)
- maniglione laterale in acciaio
- chiusura centralizzata
- cassetti dotati di tappetino interno in gomma



**SISTEMA DI APERTURA A BAIONETTA**



**MANIGLIONE IN ACCIAIO**



**TOP IN GOMMA**

**FG101**

CODICE	CASSETTI	€/LISTINO	€/PROMO
FG 101V/5G	5 CASSETTI	680,00	359,00
FG 101V/6G	6 CASSETTI	710,00	379,00
FG 101V/7G	7 CASSETTI	750,00	399,00



**2 RIPIANI (SUPERIORE E INFERIORE) PORTA OGGETTI 680X440MM**



**POSSIBILITA' DI INSERIMENTO MODULI UTENSILERIA**

**FG 101V/3G**

**500,00€ 249,00€**

**CARRELLO PORTA UTENSILI A 3 CASSETTI MOD. FG 101**



**DOTATO DI 16 VASCHETTA AMOVIBILI PORTA MINUTERIE**



**STRUTTURA LATERALE IN ALLUMINIO E RIPIANI E ACCESSORI IN ABS**

**FG 108/B**

**180,00€ 89,00€**

**CARRELLO MULTI-SERVIZIO UNIVERSALE PER MINUTERIE E ATTREZZI DA LAVORO**



CODICE				CASSETTI	€/LISTINO	€/PROMO
FG 160V/14L	FG 160B/14L	FG 160R/14L	FG 160D/14L	14 CASSETTI	-3.550,00-	1.889,00

**FG 160**

**CARRELLO PORTA UTENSILI MOD. FG 160**

**CARATTERISTICHE TECNICHE:**

- Guide telescopiche con sistema di aggancio automatico
- 4 ruote in gomma vulcanizzata Ø160mm
- maniglione laterale in acciaio
- chiusura centralizzata
- cassetti dotati di tappetino interno in gomma



- Antina apribile a 90°, dotata di serratura con chiave  
- 2 ripiani interni amovibili



- 7 cassetti porta minuteria  
Profondità: 580x235mm



- Larga griglia laterale porta utensili  
Dimensioni: 665x595mm

**KG 2.400**  
**PORTATA STATICA**

**JUMBO**

**MADE IN ITALY**

**FG 94/MS**

**SUPPORTO MAGNETICO PORTA UTENSILI**



PVC ANTI-GRAFFIO



~~34,00€~~ **18,90€**

**FG 94/MI**

**SUPPORTO MAGNETICO PORTA UTENSILI**

DIMENSIONI: 120x94x400mm

**KG 9**  
**PORTATA MASSIMA**



~~52,00€~~ **24,90€**



**FG 94/R**

**PORTA MINUTERIE MAGNETICO**

Dimensione: 165x245mm

~~20,00€~~ **11,90€**



**FG 94/T**

**PORTA MINUTERIE MAGNETICO**

Ø 150mm

~~17,00€~~ **9,90€**



# CARRELLI E BANCHI DA LAVORO



**FG 101V/AS106**

**CARRELLO PORTA UTENSILI A 3 CASSETTI MOD. FG 101 CON ASSORTIMENTO 106 UTENSILI IN MODULI RIGIDI**

~~1.295,00€~~ **499,00€**



**2 RIPIANI (SUPERIORE E INFERIORE) PORTA OGGETTI 680X440MM**



**POSSIBILITA' DI INSERIMENTO MODULI UTENSILERIA**

## 1°CASSETTO

- **FG 102/03G:** Modulo 14 chiavi combinate 6 - 19mm
- **FG 102/17:** Modulo 11 chiavi a bussola da 1/4" 4-14mm + accessori
- **FG 102/21E:** Modulo chiavi a bussola esagonali 1/2" 8-32mm + accessori



## 2°CASSETTO

- **FG 102/48D:** Modulo inserti + portainseri 1/4"
- **FG 102/VA1:** Modulo porta minuterie
- **FG 102/65B:** Modulo pinza autobloccante e pinza regolabile a cerniera aperta



## 3°CASSETTO

- **FG 102/45D:** Modulo 6 giraviti taglio e croce
- **FG 102/45I:** Modulo 6 giraviti con impronta Torx
- **FG 102/39D:** Modulo 3 pinze



**FG 101V/AS136**

**CARRELLO PORTA UTENSILI FG 101  
A 6 CASSETTI CON ASSORTIMENTO  
136 UTENSILI IN MODULI RIGIDI**

~~1.830,00€~~ **699,00€**

**KG 500** **PORTATA  
STATICA**



**SISTEMA DI APERTURA  
A BAIONETTA**



**MANIGLIONE IN  
ACCIAIO**



**TOP IN GOMMA**

**1°CASSETTO**

- **FG 102/03G:** Modulo 14 chiavi combinate 6 - 19mm
- **FG 102/17:** Modulo 11 chiavi a bussola da 1/4" 4-14mm + accessori
- **FG 102/21E:** Modulo chiavi a bussola esagonali 1/2" 8-32mm + accessori

**2°CASSETTO**

- **FG 102/21TX:** Modulo 44 utensili con impronta Torx
- **FG 102/21H:** Modulo rigido inserti a bussola 1/2" esagonali e XZN
- **FG 102/65B:** Modulo pinza autobloccante e pinza regolabile a cerniera aperta

**3°CASSETTO**

- **FG 102/45D:** Modulo 6 giraviti taglio e croce
- **FG 102/45I:** Modulo 6 giraviti con impronta Torx
- **FG 102/39D:** Modulo 3 pinze





# CARRELLI E BANCHI DA LAVORO



**FG 101V/AS187**

**CARRELLO PORTA UTENSILI FG 101  
A 7 CASSETTI CON ASSORTIMENTO  
187 UTENSILI IN MODULI RIGIDI**

~~2.024,00€~~ **799,00€**

**KG 500** **PORTATA  
STATICA**



**SISTEMA DI APERTURA  
A BAIONETTA**



**MANIGLIONE IN  
ACCIAIO**



**TOP IN GOMMA**

## 1°CASSETTO

- **FG 102/03G:** Modulo 14 chiavi combinate 6 - 19mm
- **FG 102/17E:** Modulo 65 utensili da 1/4"
- **FG 102/21E:** Modulo chiavi a bussola esagonali 1/2" 8-32mm + accessori



## 2°CASSETTO

- **FG 102/39D:** Modulo 3 pinze
- **FG 102/45I:** Modulo 6 giraviti con impronta Torx
- **FG 102/45D:** Modulo 6 giraviti taglio e croce



## 3°CASSETTO

- **FG 102/48G:** Modulo 52 inserti - attacco 10mm
- **FG 102/60D:** Modulo utensili per manutenzione
- **FG 102/23C:** Modulo 14 utensili rinforzati da 1/2"



## 4°CASSETTO

- **FG 618/A8, A10, A13, A17, A19:** Chiavi a T esagonali snodate



**FG 102V/AS158**

**CARRELLO PORTA UTENSILI FG 102  
A 6 CASSETTI CON ASSORTIMENTO  
158 UTENSILI IN MODULI RIGIDI**

~~2.571,00€~~ **999,00€**

**KG  
800** **PORTATA  
STATICA**



CODICE			
FG 102V/AS158	FG 102B/AS158	FG 102R/AS158	FG 102D/AS158



**4 RUOTE Ø125  
(2 GIREVOLI-2 FISSE)**



**TOP IN GOMMA**



**MANIGLIONE IN  
ACCIAIO**

**1°CASSETTO**

- **FG 102/03G:** Modulo 14 chiavi combinate 6 - 19mm
- **FG 102/21B:** Modulo chiavi a bussola esagonali 1/2" 8-32mm + accessori
- **FG 102/17:** Modulo 11 chiavi a bussola da 1/4" 4-14mm + accessori

**2°CASSETTO**

- **FG 102/21TX:** Modulo 44 utensili TORX
- **FG 102/21H:** Modulo rigido inserti a bussola 1/2" esagonali e XZN
- **FG 102/39XT:** Modulo 3 pinze - serie Industrial

**3°CASSETTO**

- **FG 102/45F:** Modulo 6 giraviti a croce phillips
- **FG 102/45G:** Modulo 7 giraviti ad intaglio
- **FG 102/45I:** Modulo 6 giraviti TORX

**4°CASSETTO**

- **FG 102/10C:** Modulo 8 chiavi a T snodate esagonali 7-19mm





# CARRELLI E BANCHI DA LAVORO



FG 102V/AS168

NEW

CARRELLO PORTA UTENSILI FG 102  
A 7 CASSETTI CON ASSORTIMENTO  
168 UTENSILI IN MODULI RIGIDI

~~2.556,00€~~

1.099,00€

KG  
800  
PORTATA  
STATICA



CODICE

FG 102V/AS168

FG 102B/AS168

FG 102R/AS168

FG 102D/AS168



4 RUOTE Ø125  
(2 GIREVOLI-2 FISSE)



TOP IN GOMMA



MANIGLIONE IN  
ACCIAIO

## 1°CASSETTO

- FG 102/03G: Modulo 14 chiavi combinate 6 - 19mm
- FG 102/21B: Modulo chiavi a bussola esagonali 1/2" 8-32mm + accessori
- FG 102/17E: Modulo 65 utensili da 1/4"

## 2°CASSETTO

- FG 102/42C: Modulo 4 pinze per anelli elastici
- FG 102/39XT: Modulo 3 pinze - serie Industrial
- FG 102/21H: Modulo rigido inserti a bussola 1/2" esagonali e XZN



## 3°CASSETTO

- FG 102/45F: Modulo 6 giraviti a croce phillips
- FG 102/45G: Modulo 7 giraviti ad intaglio
- FG 102/45I: Modulo 6 giraviti TORX

## 4°CASSETTO

- FG 102/56C: Modulo utensili da percussione
- FG 102/60D: Modulo utensili per manutenzione
- FG 102/65B: Modulo pinza autobloccante e inza regolabile a cerniera aperta





**FG 100V/AS212**

**NEW**

**CARRELLO PORTA UTENSILI FG 100  
A 7 CASSETTI CON ASSORTIMENTO  
212 UTENSILI IN MODULI RIGIDI**

~~2.721,00€~~ **1.099,00€**

**KG  
800** **PORTATA  
STATICA**



**CODICE**

FG 100V/AS212	FG 100B/AS212	FG 100R/AS212	FG 100D/AS212	FG 100W/AS212
---------------	---------------	---------------	---------------	---------------



**SISTEMA DI CHIUSURA  
LATERALE**



**RIPIANO SUPERIORE  
IN ABS**



**CASSETTO CON  
APERTURA COMPLETA**

**1°CASSETTO**

- **FG 102/03G:** Modulo 14 chiavi combinate 6 - 19mm
- **FG 102/03L:** Modulo 6 chiavi combinate
- **FG 102/21B:** Modulo chiavi a bussola esagonali 1/2" 8-32mm + accessori

**2°CASSETTO**

- **FG 102/17E:** Modulo 65 utensili da 1/4"
- **FG 102/19:** Modulo utensili con attacco quadro 3/8"
- **FG 102/45I:** Modulo 6 giraviti con impronta Torx



**3°CASSETTO**

- **FG 102/39XT:** Modulo 3 pinze - serie Industrial
- **FG 102/39D:** Modulo 3 pinze
- **FG 102/45E:** Modulo 8 giraviti ad intaglio e a croce phillips

**4°CASSETTO**

- **FG 102/56C:** Modulo utensili da percussione
- **FG 102/65B:** Modulo pinza autobloccante e inza regolabile a cerniera aperta
- **FG 102/48G:** Modulo inserti corti e lunghi con attacco 10mm





# CARRELLI E BANCHI DA LAVORO



FG 100V/AS183

NEW

CARRELLO PORTA UTENSILI FG 100  
A 7 CASSETTI CON ASSORTIMENTO  
183 UTENSILI IN MODULI RIGIDI

~~2.647,00€~~ 1.149,00€

KG  
800 PORTATA  
STATICA



SISTEMA DI CHIUSURA  
LATERALE



RIPIANO SUPERIORE  
IN ABS



CASSETTO CON  
APERTURA COMPLETA



CODICE

FG 100V/AS183	FG 100B/AS183	FG 100R/AS183	FG 100D/AS183	FG 100W/AS183
---------------	---------------	---------------	---------------	---------------

## 1°CASSETTO

- FG 102/03G: Modulo 14 chiavi combinate 6 - 19mm
- FG 102/03L: Modulo rigido 6 chiavi combinate
- FG 102/21B: Modulo chiavi a bussola esagonali 1/2" 8-32mm + accessori



## 2°CASSETTO

- FG 102/17: Modulo 11 chiavi a bussola da 1/4" 4-14mm + accessori
- FG 102/48G: Modulo inserti corti e lunghi con attacco 10mm
- FG 102/21TX: Modulo 44 utensili Torx



## 3°CASSETTO

- FG 102/39XT: Modulo 3 pinze - serie Industrial
- FG 102/45D: Modulo 6 giraviti a taglio e a croce
- FG 102/45I: Modulo 6 giraviti con impronta Torx



## 4°CASSETTO

- FG 102/10C: Modulo 8 chiavi a T snodate esagonali 7-19mm





**FG 100V/AS371**

**NEW**

**CARRELLO PORTA UTENSILI FG 100  
A 7 CASSETTI CON ASSORTIMENTO  
371 UTENSILI IN MODULI RIGIDI**

~~3.718,80€~~ **1.399,00€**

**KG  
800** **PORTATA  
STATICA**



**CODICE**

**FG 100V/AS371 | FG 100B/AS371 | FG 100R/AS371 | FG 100D/AS371 | FG 100W/AS371**



- **FG 102/03G:** Modulo 14 chiavi combinate 6 - 19mm
- **FG 102/03L:** Modulo rigido 6 chiavi combinate
- **FG 102/03E:** Modulo 8 chiavi doppia forchetta
- **FG 102/17E:** Modulo 65 utensili da 1/4"
- **FG 102/19:** Modulo utensili con attacco quadro 3/8"
- **FG 102/21B:** Modulo utensili con attacco quadro 1/2"
- **FG 102/21TX:** Modulo utensili torx con attacco 1/4" e 1/2"
- **FG 102/21H:** Modulo inserti a bussola esagonali e xzn con attacco 1/2"
- **FG 102/21R:** Modulo inserti a bussola ribe con attacco 1/2"

- **FG 102/56C:** Modulo utensili da percussione
- **FG 102/39XT:** Modulo 3 pinze - serie Industrial
- **FG 102/42C:** Modulo 4 pinze per anelli elastici
- **FG 102/45G:** Modulo 7 giraviti con testa ad intaglio
- **FG 102/45F:** Modulo 6 giraviti con testa a croce phillips
- **FG 102/45I:** Modulo 6 giraviti con impronta Torx
- **FG 102/48G:** Modulo 52 inserti con attacco 10mm + adattatore
- **FG 102/65B:** Modulo pinze autobloccanti
- **FG 102/23C:** Modulo 14 utensili rinforzati da 1/2"
- **FG 85/S31:** SET INSERTI DA 1/4" + ADATTATORE PORTA INSERTI 1/4"x1/4"

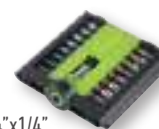



# CARRELLI E BANCHI DA LAVORO



**FG 102/03G**

~~140,00€~~ **85,00€**

**MODULO RIGIDO 14 CHIAVI COMBinate**

6, 7, 8, 9, 10, 11, 12, 13, 14, 15, 16, 17, 18, 19 mm



**FG 102/03H**

**MODULO RIGIDO 18 CHIAVI COMBinate**

6, 7, 8, 10, 11, 12, 13, 14, 16, 17, 18, 19, 21, 22, 24, 27, 30, 32 mm

~~250,00€~~ **149,00€**



**FG 102/03L**

~~145,00€~~ **89,00€**

**MODULO RIGIDO 6 CHIAVI COMBinate**

21, 22, 24, 27, 30, 32 mm



**FG 102/03E**

**MODULO RIGIDO 8 CHIAVI A DOPPIA FORCHETTA**

6x7-20x22 mm + 139C/FS

~~80,00€~~ **49,00€**



**FG 102/03F**

**MODULO RIGIDO 5 CHIAVI A DOPPIA FORCHETTA**

21x23, 24x26, 25x28, 27x29, 30x32 mm

~~96,00€~~ **59,00€**



**FG 102/07C**

~~96,00€~~ **59,00€**

**MODULO 7 CHIAVI DOPPIE POLIGONALI**

6x7, 8x9, 10x11, 12x13, 14x15, 16x17, 18x19mm



**FG 102/07D**

~~135,00€~~ **79,00€**

**MODULO 5 CHIAVI DOPPIE POLIGONALI**

20x22, 21x23, 24x27, 25x28, 30x32mm



**FG 102/08C**

~~245,00€~~ **145,00€**

**MODULO 11 CHIAVI COMBinate A CRICCO REVERSIBILE**

8, 10, 11, 12, 13, 14, 15, 16, 17, 18, 19mm



**FG 102/10C**

**MODULO 8 CHIAVI A T SNODATE ESAGONALI**

7, 8, 10, 11, 13, 14, 17, 19 mm

~~330,00€~~ **199,00€**



**FG 102/13C**

~~185,00€~~ **109,00€**

**MODULO 10 CHIAVI A PIPA ESAGONALI-POLIGONALI**

6,7,8,10,11,12,13,14, 17,19mm



**FG 102/17**

**MODULO 18 UTENSILI DA 1/4"**

4-14mm

~~132,00€~~ **79,00€**



**FG 102/17E**

**MODULO 65 UTENSILI DA 1/4"**

~~265,00€~~ **159,00€**



**FG 102/19**

**MODULO 18 UTENSILI DA 3/8"**  
8-23mm ESAGONALI

~~200,00€~~ **119,00€**



**FG 102/19B**

**MODULO 18 UTENSILI DA 3/8"**  
8-23mm POLIGONALI

~~180,00€~~ **109,00€**



**FG 102/21B**

**MODULO 25 UTENSILI DA 1/2"**  
10-32mm ESAGONALI

~~240,00€~~ **139,00€**



**FG 102/21C**

**MODULO 25 UTENSILI DA 1/2"**  
10-32mm POLIGONALI

~~240,00€~~ **139,00€**



**FG 102/21E**

**MODULO 16 UTENSILI DA 1/2"**  
10-32mm ESAGONALI

~~165,00€~~ **99,00€**



**FG 102/21D**

**MODULO 16 UTENSILI DA 1/2"**  
10-32mm POLIGONALI

~~165,00€~~ **99,00€**



**FG 102/21TX**

**MODULO 44 UTENSILI TORX**

~~235,00€~~ **139,00€**



**FG 102/21H**

**MODULO RIGIDO INSERTI A  
BUSSOLA 1/2" ESAGONALI E XZN**

~~200,00€~~ **119,00€**

**FG 102/25**

**MODULO  
9 UTENSILI DA 3/4"**  
34-50mm ESAGONALI

~~395,00€~~  
**239,00€**



**FG 102/25B**

**MODULO  
9 UTENSILI DA 3/4"**  
34-50mm POLIGONALI

~~395,00€~~  
**239,00€**



**FG 102/21R**

**MODULO INSERTI A  
BUSSOLA RIBE**  
R4-R14, LR4.LR14

~~220,00€~~ **135,00€**



**FG 102/23C**

**MODULO 14 UTENSILI RINFORZATI DA 1/2"**  
10,11,12,13,14,16,17,18,19,21,22,23,24mm + FG 628/PR125

~~145,50€~~ **85,00€**



**FG 102/51H**

**MODULO 7 CHIAVI A T MASCHIO ESAGONALI**  
10,11,12,2, 2.5, 3, 4, 5, 6, 8mm

~~130,00€~~ **79,00€**



**FG 102/39XT**

**MODULO 3 PINZE SERIE INDUSTRIAL**  
FG 59/XT180 - FG 61/XT160 - FG 63TXT160

~~96,00€~~ **59,00€**



**FG 102/39D**

**MODULO 3 PINZE CON MANICI IN PVC**  
FG 59PV/180, FG 61PV/160, FG 63PV/160

~~74,00€~~ **45,00€**



# CARRELLI E BANCHI DA LAVORO



FG 102/41C

~~96,00€~~

56,00€

MODULO 4 PINZE PER ANELLI ELASTICI

Capacità: 8-25mm



FG 102/42C

~~106,00€~~

59,90€

MODULO 4 PINZE PER ANELLI ELASTICI

Capacità: 19-60mm



FG 102/45D

~~45,00€~~

26,90€

MODULO 6 GIRAVITI AD INTAGLIO E A CROCE PHILLIPS

3x100, 4x125, 5.5x150, 6.5x150, PH1x80, PH2x150



FG 102/45E

~~55,00€~~

32,90€

MODULO 8 GIRAVITI AD INTAGLIO E A CROCE PHILLIPS

3x100, 4x125, 5.5x150, 6.5x150, 6.5x38, PH1x80, PH2x150, PH2x38



FG 102/45U

MODULO 12 GIRAVITI AD INTAGLIO E A CROCE PHILLIPS

2.5x60, 3x75, 4x30, 4x100, 5.5x150, 8x150, PH0x60, PH1x30, PH1x80, PH2x100, PH3x150

~~96,00€~~

57,90€

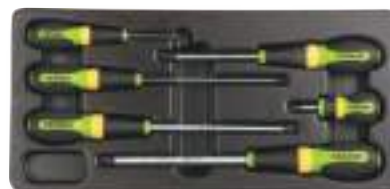

FG 102/45F

~~52,00€~~

31,90€

MODULO 6 GIRAVITI A CROCE PHILLIPS

PH0x60, PH1x150, PH2x100, PH2x150, PH3x150, PH2x38



FG 102/45G

~~52,00€~~

31,90€

MODULO 7 GIRAVITI AD INTAGLIO

2.5x60, 3x100, 3.5x100, 4x125, 5.5x150, 5.5x100, 6.5x150



FG 102/45I

~~64,00€~~

38,90€

MODULO 6 GIRAVITI TORX

TX10, TX15, TX20, TX25, TX27, TX30



FG 102/45L

~~65,00€~~

39,00€

MODULO 6 GIRAVITI TORX CON FORO

RTX10, RTX15, RTX20, RTX25, RTX27, RTX30



FG 102/45T

~~75,00€~~

39,00€

MODULO 5 GIRAVITI A BUSSOLA ESAGONALI

FX6, FX7, FX8, FX10, FX13

**FG 102/48D**
~~95,00€~~ **56,90€**
**MODULO 40 INSERTI DA 1/4"  
+ PORTA INSERTI**

**FG 102/48G**
~~120,00€~~ **72,00€**
**MODULO 52 INSERTI DA 10MM  
+ ADATTATORE PER CRICCHETTO DA 1/2"**

**FG 102/50F**
~~76,00€~~ **45,00€**
**MODULO 6 CHIAVI MASCHIO ESAGONALI  
2, 2.5, 3, 4, 5, 6mm**

**FG 102/50G**
~~76,00€~~ **45,00€**
**MODULO 6 CHIAVI MASCHIO TORX  
TX10, TX15, TX20, TX25, TX27, TX30**

**FG 102/56C**
~~125,00€~~ **75,00€**
**MODULO UTENSILI DA PERCUSSIONE  
FG 132/500, FG 136/40, FG 126/SN1, FG 126/SN3**

**NEW**
**FG 102/60D**
~~51,00€~~ **29,90€**
**MODULO UTENSILI PER MANUTENZIONE  
FG 44/MT5, FG 50/AR, FG 48/LG, FG 79/SP4, FG 497/OP1**

**FG 102/62B**
~~90,00€~~ **55,00€**
**MODULO 5 LIME A TAGLIO MEZZODOLCE**

**FG 102/VA1**
~~15,00€~~ **8,90€**
**MODULO PORTA MINUTERIE**

**FG 102/65B**
~~65,00€~~ **39,00€**
**MODULO PINZA AUTOBLOCCANTE  
E PINZA REGOLABILE A CERNIERA APERTA**



# CARRELLI E BANCHI DA LAVORO



**FG 102V/AS183**

**CARRELLO PORTA UTENSILI FG 102  
A 7 CASSETTI CON ASSORTIMENTO  
183 UTENSILI IN MODULI DI GOMMA**

~~2.524,50€~~ **999,00€**

**KG  
800** PORTATA  
STATICA



**CODICE**

**FG 102V/AS183 | FG 102B/AS183 | FG 102R/AS183 | FG 102D/AS183**



**4 RUOTE Ø125  
(2 GIREVOLI-2 FISSE)**



**TOP IN GOMMA**



**MANIGLIONE IN  
ACCIAIO**

## 1°CASSETTO

- **FG 100/03G:** Modulo 14 chiavi combinate 6 - 19mm
- **FG 100/VA1:** Modulo porta minuterie
- **FG 100/03E:** Modulo 8 chiavi a forchetta 6x7-20x22mm + set 9 chiavi maschio esagonali

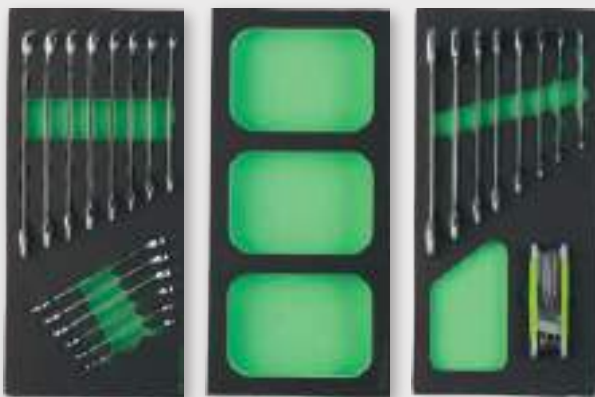

## 2°CASSETTO

- **FG 100/17E:** Modulo 65 utensili da 1/4"
- **FG 100/VA1:** Modulo porta minuterie
- **FG 100/21B:** Modulo chiavi a bussola esagonali 1/2" 8-32mm + accessori

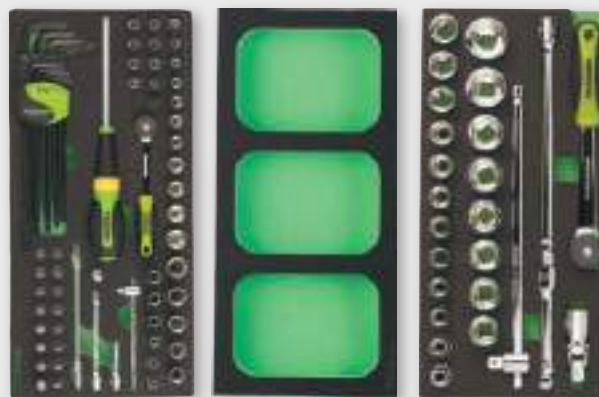

## 3°CASSETTO

- **FG 100/39XT:** Modulo 3 pinze assortite - serie industrial
- **FG 100/65B:** Modulo pinze autobloccanti
- **FG 100/48D:** Modulo 40 inserti da 1/4" + porta inserti



## 4°CASSETTO

- **FG 100/45F:** Modulo 6 giraviti a croce Phillips
- **FG 100/45G:** Modulo 7 giraviti a taglio
- **FG 100/56C:** Modulo utensili da percussione





**FG 100VD/AS182**

~~2.923,50€~~ **1.199,00€**

**NEW**

**CARRELLO BI COLOR PORTA UTENSILI FG 100  
A 7 CASSETTI CON ASSORTIMENTO  
182 UTENSILI IN MODULI DI GOMMA**

**KG  
800** **PORTATA  
STATICA**



**1°CASSETTO**

- **FG 100/03G:** Modulo 14 chiavi combinate 6 - 19mm
- **FG 100/VA1:** Modulo porta minuterie
- **FG 100/08C:** Modulo 8 chiavi combinate a cricco

**2°CASSETTO**

- **FG 100/17:** Modulo utensili con attacco quadro 1/4"
- **FG 100/21TX:** Modulo utensili torx con attacco 1/4" e 1/2"
- **FG 100/21B:** Modulo utensili con attacco quadro 1/2"

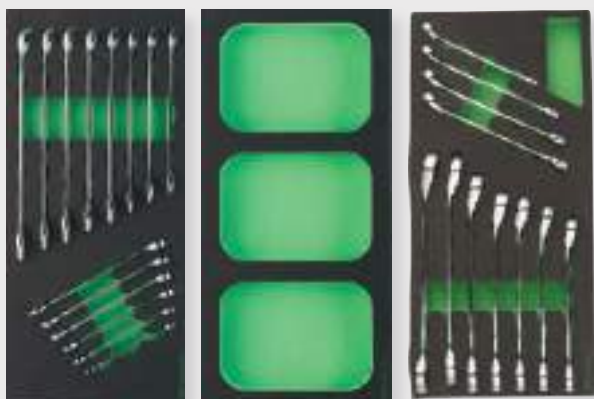

**3°CASSETTO**

- **FG 100/65B:** Modulo pinze autobloccanti
- **FG 100/45I:** Modulo 6 giraviti con impronta torx
- **FG 100/45D:** Modulo 6 giraviti a taglio e croce

**4°CASSETTO**

- **FG 100/39XT:** Modulo 3 pinze assortite - serie industrial
- **FG 100/VA1:** Modulo porta minuterie
- **FG 100/48G:** Modulo inserti corti e lunghi con attacco 10mm

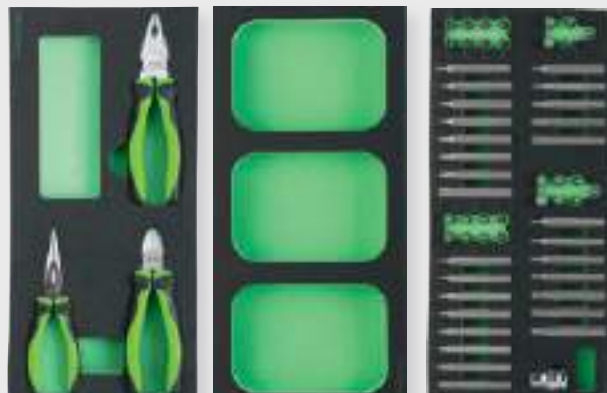



# CARRELLI E BANCHI DA LAVORO



## FG 100V/AS224

CARRELLO PORTA UTENSILI FG 100  
A 7 CASSETTI CON ASSORTIMENTO  
224 UTENSILI IN MODULI DI GOMMA

~~2.832,50€~~ **1.199,00€**



**PORTATA  
STATICA**



### CODICE

FG 100V/AS224 | FG 100B/AS224 | FG 100R/AS224 | FG 100D/AS224 | FG 100W/AS224



**SISTEMA DI CHIUSURA  
LATERALE**



**RIPIANO SUPERIORE  
IN ABS**



**CASSETTO CON  
APERTURA COMPLETA**

### 1°CASSETTO

- **FG 100/03G:** Modulo 14 chiavi combinate 6 - 19mm
- **FG 100/17E:** Modulo 65 utensili da 1/4"
- **FG 100/21B:** Modulo chiavi a bussola esagonali 1/2" 8-32mm + accessori

### 2°CASSETTO

- **FG 100/39XT:** Modulo 3 pinze assortite - serie industrial
- **FG 100/VA1:** Modulo porta minuterie
- **FG 100/21TX:** Modulo 44 utensili TORX



### 3°CASSETTO

- **FG 100/45I:** Modulo 6 giraviti con impronta Torx
- **FG 100/45D:** Modulo 6 giraviti a taglio e croce
- **FG 100/48G:** Modulo inserti corti e lunghi con attacco 10mm

### 4°CASSETTO

- **FG 100/10C:** Modulo 8 chiavi a T snodate 7-19mm





**FG 100VD/AS212**

**CARRELLO BI COLOR PORTA UTENSILI FG 100  
A 7 CASSETTI CON ASSORTIMENTO  
212 UTENSILI IN MODULI DI GOMMA**

~~3.390,00€~~ **1.399,00€**

**NEW**



**1°CASSETTO**

- **FG 100/03G:** Modulo 14 chiavi combinate 6 - 19mm
- **FG 100/VA1:** Modulo porta minuterie
- **FG 100/03L:** Modulo 6 chiavi combinate



**2°CASSETTO**

- **FG 100/17:** Modulo utensili con attacco quadro 1/4"
- **FG 100/21TX:** Modulo utensili torx con attacco 1/4" e 1/2"
- **FG 100/21B:** Modulo utensili con attacco quadro 1/2"



**3°CASSETTO**

- **FG 100/81F:** Modulo inserti a bussola con attacco quadro 1/2"
- **FG 100/45I:** Modulo 6 giraviti con impronta torx
- **FG 100/45D:** Modulo 6 giraviti a taglio e croce

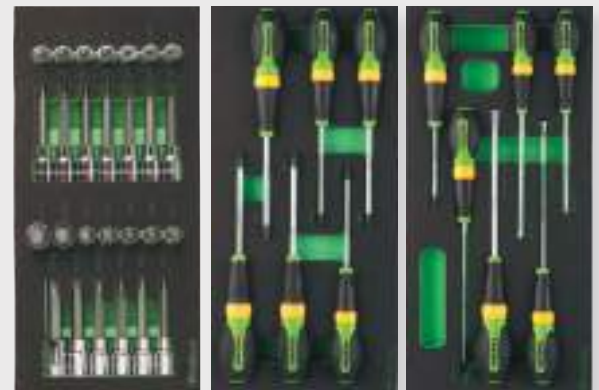

**4°CASSETTO**

- **FG 100/39XT:** Modulo 3 pinze assortite - serie industrial
- **FG 100/65B:** Modulo pinze autobloccanti
- **FG 100/48G:** Modulo inserti corti e lunghi con attacco 10mm

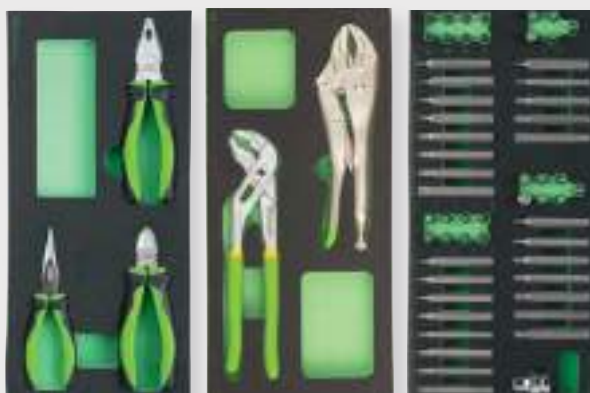

**5°CASSETTO**

- **FG 100/10C:** Modulo 8 chiavi a T snodate 7-19mm

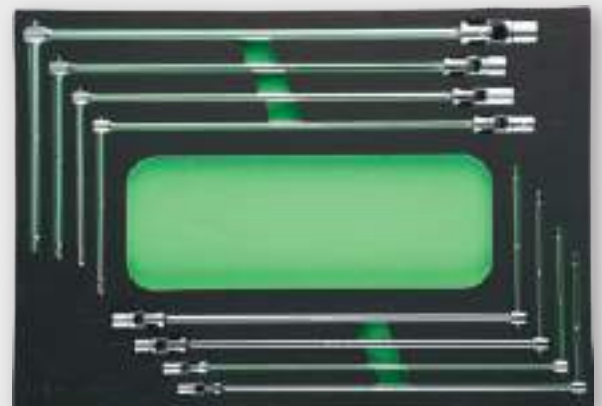



# CARRELLI E BANCHI DA LAVORO



**FG 150R/AS167**

**CARRELLO PORTA UTENSILI  
A 7 CASSETTI CON ASSORTIMENTO  
167 UTENSILI IN MODULI DI GOMMA**

~~3.004,00€~~ **1.299,00€**

## 1°CASSETTO

- **FG 100/03G:** Modulo 14 chiavi combinate 6 - 19mm
- **FG 100/VA1:** Modulo di riempimento con vani porta minuteria
- **FG 100/03E:** Modulo 8 chiavi a forchetta 6x7-20x22mm  
+ set 9 chiavi maschio esagonali



## 3°CASSETTO

- **FG 100/81F:** Modulo inserti a bussola da 1/2" esagonali e XZN
- **FG 100/42C:** Modulo 4 pinze per anelli elastici 19-60mm
- **FG 100/65B:** Modulo pinze autobloccanti e a cerniera



## 5°CASSETTO

- **FG 100/10C:** Modulo 8 chiavi a T snodate 7-19mm



## CODICE

**FG 150R/AS167 FG 150D/AS167**

**KG  
800**

**PORTATA  
STATICA**

## 2°CASSETTO

- **FG 100/17:** Modulo 11 chiavi a bussola da 1/4" esagonali + accessori
- **FG 100/21TX:** Modulo 44 utensili con impronta TORX
- **FG 100/21B:** Modulo chiavi a bussola esagonali 1/2" 8-32mm + accessori



## 4°CASSETTO

- **FG 100/39XT:** Modulo 3 pinze assortite - serie industrial
- **FG 100/VA1:** Modulo di riempimento con vani porta minuteria
- **FG 100/45D:** Modulo 6 giraviti ad intaglio e a croce phillips





**CODICE**

FG 100V/AS230	FG 100B/AS230	FG 100R/AS230	FG 100D/AS230	FG 100W/AS230
---------------	---------------	---------------	---------------	---------------

**2°CASSETTO**

- **FG 100/17E:** Modulo 65 utensili da 1/4"
- **FG 100/21TX:** Modulo 44 utensili con impronta Torx
- **FG 100/21B:** Modulo chiavi a bussola esagonali 1/2" 8-32mm + accessori



**4°CASSETTO**

- **FG 100/39XT:** Modulo 3 pinze assortite - serie industrial
- **FG 100/45D:** Modulo 6 giraviti ad intaglio e a croce phillips
- **FG 100/45I:** Modulo 6 giraviti con impronta TORX



**FG 100V/AS230**

**CARRELLO PORTA UTENSILI FG 100  
7 CASSETTI CON ASSORTIMENTO  
230 UTENSILI IN MODULI IN GOMMA**

~~3.510,50€~~ **1.399,00€**

**KG  
800** **PORTATA  
STATICA**

**1°CASSETTO**

- **FG 100/03G:** Modulo 14 chiavi combinate 6 - 19mm
- **FG 100/03L:** Modulo 6 chiavi combinate
- **FG 100/03E:** Modulo 8 chiavi a forchetta 6x7-20x22mm + set 9 chiavi maschio esagonali



**3°CASSETTO**

- **FG 100/81F:** Modulo inserti a bussola da 1/2" esagonali e XZN
- **FG 100/65B:** Modulo pinze autobloccanti
- **FG 100/42C:** Modulo 4 pinze per anelli elastici 19-60mm



**5°CASSETTO**

- **FG 100/10D:** Modulo 12 chiavi a T snodate





# CARRELLI E BANCHI DA LAVORO



## FG 100V/AS366

CARRELLO PORTA UTENSILI FG 100  
A 7 CASSETTI CON ASSORTIMENTO  
366 UTENSILI IN MODULI RIGIDI

~~3.849,30€~~ 1.499,00€



PORTATA  
STATICA



### CODICE

FG 100V/AS366 FG 100B/AS366 FG 100R/AS366 FG 100D/AS366 FG 100W/AS366



SISTEMA DI CHIUSURA  
LATERALE



RIPIANO SUPERIORE  
IN ABS



CASSETTO CON  
APERTURA COMPLETA

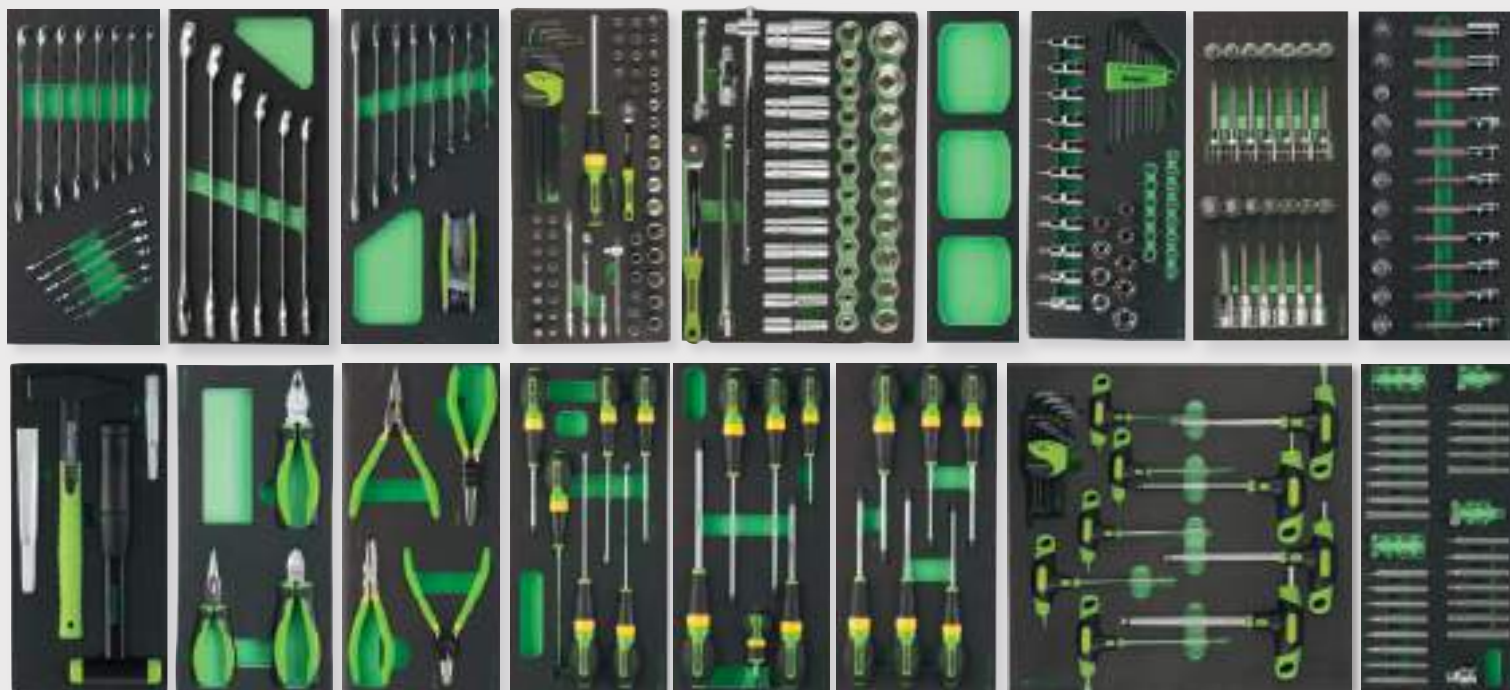

- FG 100/03G: Modulo 14 chiavi combinate 6 - 19mm
- FG 100/03L: Modulo rigido 6 chiavi combinate
- FG 100/03E: Modulo 8 chiavi doppia forchetta
- FG 100/17E: Modulo 65 utensili da 1/4"
- FG 100/21H: Modulo utensili con attacco quadro 1/2"
- FG 100/VA4: Modulo vuoto porta minuterie
- FG 100/21TX: Modulo utensili torx con attacco 1/4" e 1/2"
- FG 100/81F: Modulo inserti a bussola esagonali e xzn con attacco 1/2"
- FG 100/82B: Modulo inserti a bussola ribe con attacco 1/2"

- FG 100/56C: Modulo utensili da percussione
- FG 100/39XT: Modulo 3 pinze assortite - serie industrial
- FG 100/42C: Modulo 4 pinze per anelli elastici
- FG 100/45G: Modulo 7 giraviti con testa ad intaglio
- FG 100/45F: Modulo 6 giraviti con testa a croce phillips
- FG 100/45I: Modulo 6 giraviti con impronta Torx
- FG 100/50E: Modulo chiavi maschio esagonali e Torx
- FG 100/48G: Modulo 52 inserti con attacco 10mm + adattatore
- FG 85/S31: SET INSERTI DA 1/4" + ADATTATORE PORTA INSERTI 1/4"x1/4"

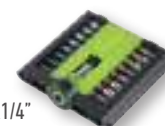

**FG 100VD/AS355**
~~4.138,90€~~ **1.599,00€**
**CARRELLO BI COLOR PORTA UTENSILI FG 100  
A 7 CASSETTI CON ASSORTIMENTO  
355 UTENSILI IN MODULI DI GOMMA**
**NEW**
**KG  
800** **PORTATA  
STATICA**

- **FG 100/03G:** Modulo 14 chiavi combinate 6 - 19mm
- **FG 100/07C:** Modulo 7 chiavi doppie poligonali
- **FG 100/03E:** Modulo 8 chiavi doppia forchetta
- **FG 100/17E:** Modulo 65 utensili da 1/4"
- **FG 100/19:** Modulo utensili con attacco quadro 3/8"
- **FG 100/21B:** Modulo utensili con attacco quadro 1/2"
- **FG 100/21TX:** Modulo utensili torx con attacco 1/4" e 1/2"
- **FG 100/81F:** Modulo inserti a bussola esagonali e xzn con attacco 1/2"
- **FG 100/82B:** Modulo inserti a bussola ribe con attacco 1/2"

- **FG 100/48G:** Modulo 52 inserti con attacco 10mm + adattatore
- **FG 100/45I:** Modulo 6 giraviti con impronta Torx
- **FG 100/45D:** Modulo 6 giraviti taglio e croce
- **FG 100/65B:** Modulo pinze autobloccanti
- **FG 100/42C:** Modulo 4 pinze per anelli elastici
- **FG 100/39XT:** Modulo 3 pinze assortite - serie industrial
- **FG 100/10C:** Modulo 8 chiavi a T snodate 7-19mm
- **FG 85/S31:** SET INSERTI DA 1/4" + ADATTATORE PORTA INSERTI 1/4"x1/4"

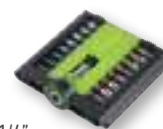



# CARRELLI E BANCHI DA LAVORO



KG  
1000

**PORTATA  
STATICA**

**FG 104D/AS242**

**CARRELLO PORTA UTENSILI FG 104  
A 7 CASSETTI CON ASSORTIMENTO  
246 UTENSILI IN MODULI DI GOMMA**

~~3.928,00€~~ **1.499,00€**



**CODICE**

FG 104V/AS242 FG 104D/AS242 FG 104B/AS242 FG 104R/AS242



**MANIGLIONE IN  
ACCIAIO INOX**



**CHIUSURA  
CENTRALIZZATA**

## 1°CASSETTO

- **FG 100/03G:** Modulo 14 chiavi combinate 6 - 19mm
- **FG 100/03L:** Modulo 6 chiavi combinate 21 - 32mm
- **FG 100/VA4:** Modulo di riempimento con vani porta minuteria
- **FG 100/21H:** Modulo 32 chiavi a bussola esagonali da 1/2" 8-32m + acc.



## 2°CASSETTO

- **FG 100/17E:** Modulo 65 utensili da 1/4"
- **FG 100/21TX:** Modulo 44 utensili con impronta Torx
- **FG 100/81F:** Modulo inserti a bussola da 1/2" esagonali e XZN
- **FG 100/23C:** Modulo 20 chiavi a bussola rinforzate da 1/2"



## 3°CASSETTO

- **FG 100/42C:** Modulo 4 pinze per anelli elastici 19-60mm
- **FG 100/39XT:** Modulo 3 pinze assortite - serie industrial
- **FG 100/45D:** Modulo 6 giraviti ad intaglio e a croce Phillips
- **FG 100/45I:** Modulo 6 giraviti con impronta Torx



## 4°CASSETTO

- **FG 100/65B:** Modulo pinza autobloccante e pinza regolabile a cerniera
- **FG 100/10C:** Modulo 8 chiavi a T snodate esagonali

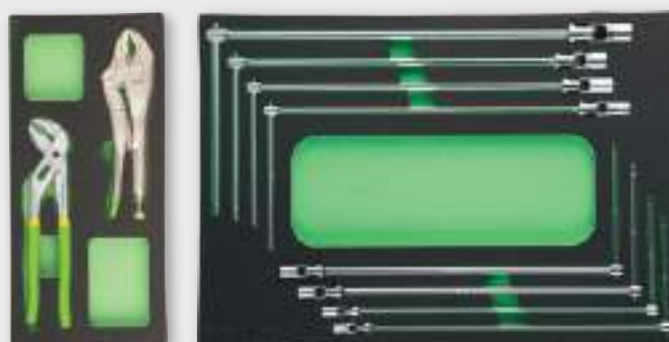



**FG 160V/AS290**

**CARRELLO PORTA UTENSILI A 14 CASSETTI  
MOD. FG 160 CON ASSORTIMENTO  
290 UTENSILI IN MODULI DI GOMMA**

~~6.098,50€~~ **2.999,00€**



**CODICE**

**FG 160B/AS290 FG 160R/AS290 FG 160D/AS290**



**PORTATA  
STATICA**

**6 CASSETTI COMPLETI DI UTENSILI**



- **FG 100/03H:** Modulo 18 chiavi combinate in mm
- **FG 100/17E:** Modulo 65 utensili da 1/4"
- **FG 100/21B:** Modulo 25 utensili da 1/2"
- **FG 100/21TX:** Modulo 44 utensili con impronta Torx
- **FG 100/19:** Modulo chiavi a bussola esagonali
- **FG 100/81F:** Modulo inserti a bussola da 1/2" esagonali e XZN
- **FG 100/VA1:** Modulo di riempimento con vani porta minuteria
- **FG 100/48G:** Modulo 52 inserti da 10mm

- **FG 100/45I:** Modulo 6 giraviti con impronta TORX
- **FG 100/45T:** Modulo 5 giraviti a bussola esagonali
- **FG 100/45D:** Modulo 6 giraviti taglio e croce
- **FG 100/65B:** Modulo pinza autobloccante e pinza regolabile a cerniera aperta
- **FG 100/39XT:** Modulo 3 pinze assortite - serie industrial
- **FG 100/45M:** Modulo 6 giraviti a testa esagonale
- **FG 100/10C:** Modulo 8 chiavi a T snodate 7-19mm

# CARRELLI ASSORTITI SETTORE CARROZZERIA



## FG 100V/AS171

~~2.851,00€~~ **1.149,00€**

**CARRELLO PORTA UTENSILI FG 100 6 CASSETTI  
CON ASSORTIMENTO 171 UTENSILI IN MODULI IN GOMMA**

**KG 800** **PORTATA STATICA**

### 1°CASSETTO

- FG 100/03G: Modulo 14 chiavi combinate 6 - 19mm
- FG 100/17E: Modulo utensili con attacco quadro 1/4"
- FG 100/39C: Modulo 3 pinze con manici rivestiti



#### CODICE

FG 100V/AS171 | FG 100B/AS171 | FG 100R/AS171 | FG 100D/AS171 | FG 100W/AS171

### 2°CASSETTO

- FG 100/45I: Modulo 6 giraviti con testa con impronta torx
- FG 100/52F: Modulo 5 raschietti in acciaio con manico in abs
- FG 100/52G: Modulo 5 utensili carrozzeria

### 3°CASSETTO

- FG 100/52A: Modulo 8 levapioli
- FG 100/52B: Modulo 26 utensili da taglio per carrozzeria
- FG 100/VA4: Modulo vuoto porta minuterie



### 4°CASSETTO

- FG 100/52C: Modulo 5 utensili per cristalli veicoli
- FG 100/52D: Modulo 10 leve in nylon
- FG 100/52E: Modulo 5 cunei in plastica

### 5°CASSETTO

- FG 100/52H: Modulo utensili manutenzione per carrozzeria





**FG 104V/AS284**

**CARRELLO PORTA UTENSILI FG 104  
7 CASSETTI CON ASSORTIMENTO 284  
UTENSILI IN MODULI IN GOMMA**

~~4.300,00€~~ **1.599,00€**



**CODICE**

FG 104V/AS284    FG 104D/AS284    FG 104B/AS284    FG 104R/AS284

**KG  
1000**

**PORTATA  
STATICA**



- **FG 100/03G:** Modulo 14 chiavi combinate
- **FG 100/17E:** Modulo 65 utensili da 1/4"
- **FG 100/21TX:** Modulo 44 utensili con impronta Torx
- **FG 100/45F:** Modulo 6 giraviti con testa a croce phillips
- **FG 100/21M:** Modulo chiavi a bussola esagonali
- **FG 100/39C:** modulo 3 pinze con manici rivestiti in bi-materiale
- **FG 100/50G:** Modulo 6 chiavi maschio torx
- **FG 100/68:** Modulo 5 levapioli
- **FG 100/45I:** Modulo 6 giraviti con impronta TORX
- **FG 100/45T:** Modulo 5 giraviti a bussola esagonali
- **FG 100/56C:** Modulo utensili da percussione
- **FG 100/81F:** Modulo inserti a bussola da 1/2" esagonali e XZN

- **FG 100/52A:** Modulo 8 levapioli
- **FG 100/52B:** Modulo 26 utensili da taglio per carrozzeria
- **FG 100/VA4:** Modulo vuoto porta minuterie
- **FG 100/52C:** Modulo 5 utensili per cristalli veicoli
- **FG 100/52D:** Modulo 10 leve in nylon
- **FG 100/52E:** Modulo 5 cunei in plastica
- **FG 100/52F:** Modulo 5 raschietti in acciaio con manico in abs
- **FG 100/52G:** Modulo 5 utensili carrozzeria
- **FG 100/52H:** Modulo utensili manutenzione per carrozzeria
- **FG 100/VA1:** Modulo vuoto porta minuterie



## THE HYBRID REVOLUTION



UTENSILI ESSENZIALI PER  
AFFRONTARE LE NUOVE  
SFIDE DEL FUTURO

**FG 603/S28A**

**FG 603/S28B**

**KIT 26 UTENSILI ISOLATI, COMPLETO DI  
ELMETTO DIELETTRICO E  
GUANTI DIELETTRICI 1.000V**

**IDEALE PER INTERVENTI SU  
VEICOLI ELETTRICI ED IBRIDI**



FG 59/IS200



FG 625E/CR12



FG 61/IS200



FG 625E/PR250



FG 63/IS160



FG 49/E



FG 603/E10,11,12,  
13,14,17,19



FG 48/IS



FG 625E/10,11,12,  
13,14,17,19



FG 22/CF250



FG 22E/4X100, 5,5X125,  
FG22E/PH1X80, PH2X100



 **1000V**  
IEC 60900

CODICE	TAGLIA GUANTI	LISTINO	€/PROMO
FG 603/S28A	TAGLIA 9	1.048,50	539,00
FG 603/S28B	TAGLIA 10	1.048,50	539,00

**FG 603/TA1**

~~278,00€~~

**145,00€**

**TAPPETO ISOLANTE 1000V**  
- 1.000x1.000x3mm



**ASSORTIMENTO 56  
UTENSILI ISOLATI**



**KG 600** PORTATA  
STATICA

**FG 100V/AS56**

**CARRELLO PORTA UTENSILI FG 100 A 6 CASSETTI CON ASSORTIMENTO 56 UTENSILI ISOLATI IN MODULI IN GOMMA**

~~2.948,60€~~ **1.299,00€**

**1°CASSETTO**

- **FG 100/03-IS: Modulo chiavi a forchetta e giraviti isolati**
- Chiavi a forchetta isolate 7-19mm
- Giraviti isolati a taglio 2.5x75mm, 3x100mm, 5.5x125mm, 6.5x150mm, 8x175mm
- Giraviti isolati per viti a croce Phillips PH0x60, PH1x80, PH2x100, PH3x150

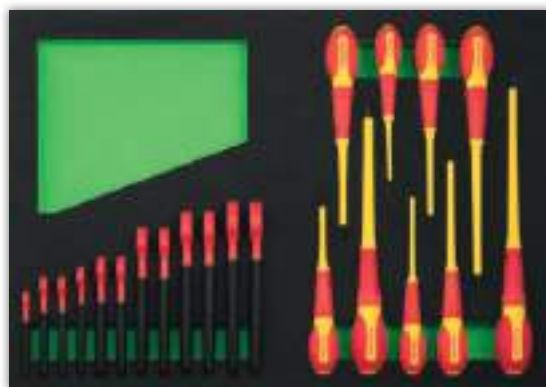

**2°CASSETTO**

- **FG 100/21-IS: Modulo bussole da 1/2 e accessori isolati**
- Chiavi a bussola esagonali da 1/2" 10-32mm
- Inserti a bussola esagonali corti e lunghi da 1/2" 4-10mm
- Accessori da 1/2"



**3°CASSETTO**

- **FG 100/39-IS: Modulo pinze e utensili da taglio isolati**
- Pinze assortite e tronchese diagonale isolate
- Forbice con manici isolati
- Cutter professionale isolato
- Spellacavi elicoidale



**SCEGLI TRA 5 VARIANTI DI COLORE LA TUA PREFERITA!**

Il nuovo carrello porta utensili FG 100 a 6 cassetti è ancora più performante e presenta **un assortimento di 56 UTENSILI ISOLATI** in moduli in gomma, **INDISPENSABILI PER LA MANUTENZIONE DI VEICOLI ELETTRICI E IBRIDI.**



CODICE				
FG 100V/AS56	FG 100B/AS56	FG 100R/AS56	FG 100D/AS56	FG 100W/AS56

# SPECIALE VEICOLI ELETTRICI



**FG 100/03G**

~~160,00€~~ **89,00€**

**MODULO 14 CHIAVI COMBinate**

6, 7, 8, 9, 10, 11, 12, 13, 14, 15, 16, 17, 18, 19 mm



**FG 100/03H**

**MODULO 18 CHIAVI COMBinate IN mm**

FG 600/B6,7,8,10,11,12,13,14,16,  
17,18,19, 21, 22, 24, 27, 30, 32mm

~~295,00€~~ **175,00€**



**FG 100/03L**

~~158,00€~~ **89,00€**

**MODULO 6 CHIAVI COMBinate**

21, 22, 24, 27, 30, 32mm



**FG 100/03E**

**MODULO 8 CHIAVI  
A DOPPIA FORCHETTA  
IMPRONTA ESAGONALE**  
6x7-20x22 mm + 139C/FS

~~95,00€~~ **56,00€**



**FG 100/03F**

**MODULO 5 CHIAVI  
A DOPPIA FORCHETTA**

21x23, 24x26, 25x28, 27x29, 30x32 mm

~~105,00€~~ **62,00€**



**FG 100/07C**

**MODULO 7 CHIAVI DOPPIE POLIGONALI**

6x7, 8x9, 10x11, 12x13, 14x15, 16x17, 18x19mm

~~109,60€~~ **59,00€**



**FG 100/07D**

**MODULO 5 CHIAVI DOPPIE POLIGONALI**

FG 615/B20x22,21x23,24x27,25x28,30x32mm

~~155,00€~~ **95,00€**



**FG 100/08C**

**MODULO 8 CHIAVI COMBinate A CRICCO**

8, 10, 11, 12, 13, 14, 15, 16, 17, 18, 19mm

~~245,00€~~ **145,00€**

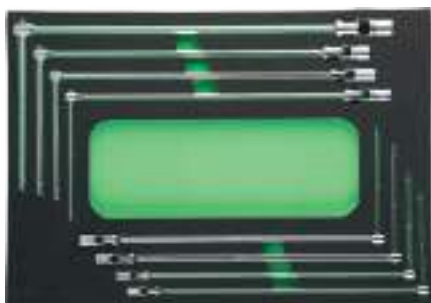

**FG 100/10C**

**MODULO 8 CHIAVI A  
T SNODATE ESAGONALI**

7, 8, 10, 11, 13, 14, 17, 19 mm

~~377,50€~~  
**229,00€**

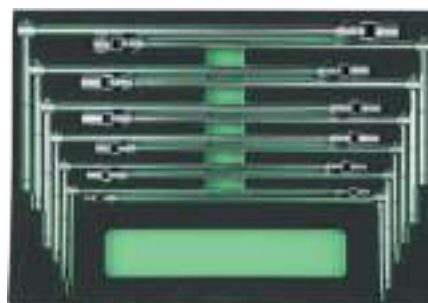

**FG 100/10D**

**MODULO 12 CHIAVI A  
T SNODATE ESAGONALI**

7, 8, 10, 11, 12, 13, 14, 15, 16,  
17, 18, 19 mm

~~549,00€~~  
**329,00€**



**FG 100/17**

**MODULO 18 UTENSILI DA 1/4"**

4-14mm

~~142,00€~~ **79,00€**



**FG 100/17E**

**MODULO 65 UTENSILI DA 1/4"**

~~285,00€~~ **169,00€**



**FG 100/18**

**MODULO CHIAVI  
A BUSSOLA ESAGONALI**

~~295,00€~~ **179,00€**



**FG 100/19**

**MODULO CHIAVI  
A BUSSOLA ESAGONALI**

~~230,00€~~ **139,00€**



**FG 100/21B**

**MODULO 25 UTENSILI DA 1/2"**  
10-32mm ESAGONALI

~~245,00€~~ **145,00€**



**FG 100/21C**

**MODULO 25 UTENSILI DA 1/2"**  
10-32mm POLIGONALI

~~245,00€~~ **145,00€**



**FG 100/21M**

**MODULO 16 UTENSILI DA 1/2"**  
10-32mm ESAGONALI

~~165,00€~~ **99,00€**



**FG 100/21D**

**MODULO 16 UTENSILI DA 1/2"**  
10-32mm POLIGONALI

~~165,00€~~ **99,00€**



**FG 100/21H**

**MODULO 32 CHIAVI A BUSSOLA ESAGONALI 1/2" + ACCESSORI**  
BUSSOLE CORTE: 8-32mm  
(esclusa 25mm)  
BUSSOLE LUNGHE: 10-32mm

~~430,00€~~ **259,00€**



**FG 100/21TX**

**MODULO 44 UTENSILI TORX**

~~260,00€~~ **155,00€**



**FG 100/81F**

**MODULO INSERTI A BUSSOLA DA 1/2" ESAGONALI XZN**

~~200,00€~~ **119,00€**



**FG 100/23B**

**MODULO 9 UTENSILI DA 3/4"**  
34-50mm ESAGONALI

~~360,00€~~ **219,00€**



**FG 100/23C**

**MODULO 20 UTENSILI RINFORZATI DA 1/2"**

10, 11, 12, 13, 14, 15, 16, 17, 18, 19, 20, 21, 22, 23, 24, 25, 26, 27, 30, 32mm

~~220,00€~~ **129,00€**



**FG 100/39XT**

**MODULO 3 PINZE ASSORTITE - SERIE INDUSTRIAL**

FG 59/XT180 - FG 61/XT160 - FG 63/XT160

~~104,00€~~ **62,90€**



**FG 100/65B**

**MODULO PINZA AUTOBLOCCANTE E PINZA REGOLABILE A CERNIERA APERTA**

~~92,50€~~ **49,90€**



**FG 100/65C**

**MODULO PINZE AUTOBLOCCANTI**  
FG 70/CJ250 - FG 58/A240 - FG 49/HE250

~~131,80€~~ **79,00€**



**FG 100/41C**

**MODULO 4 PINZE PER ANELLI ELASTICI**

Capacità: 8-25mm

~~110,00€~~ **65,00€**



**FG 100/42C**

**MODULO 4 PINZE PER ANELLI ELASTICI**

Capacità: 19-60mm

~~115,00€~~ **69,00€**



# CARRELLI E BANCHI DA LAVORO

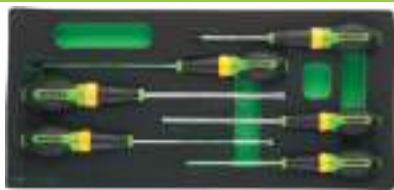

**FG 100/45D**

~~65,00€~~ **39,00€**

**MODULO 6 GIRAVITI AD INTAGLIO E A CROCE PHILLIPS**

3x100, 4x125, 5.5x150, 6.5x150, PH1x80, PH2x150



**FG 100/45E**

~~80,00€~~ **49,00€**

**MODULO 8 GIRAVITI AD INTAGLIO E A CROCE PHILLIPS**

3x100, 4x125, 5.5x150, 6.5x150, 6.5x38PH1x80, PH2x150, PH2x38

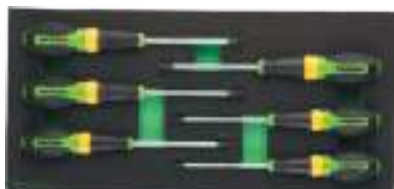

**FG 100/45I**

~~82,00€~~ **49,00€**

**MODULO 6 GIRAVITI TORX**

TX10, TX15, TX20, TX25, TX27, TX30

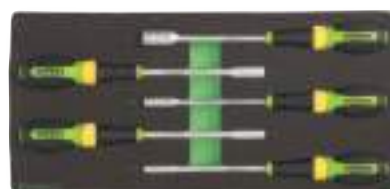

**FG 100/45T**

~~85,00€~~ **52,00€**

**MODULO 5 GIRAVITI A BUSSOLA ESAGONALI**

FX6, FX7, FX8, FX10, FX13

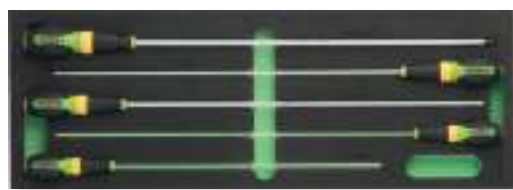

**FG 100/45H**

~~80,00€~~ **49,00€**

**MODULO 5 GIRAVITI EXTRA LUNGHI**



**FG 100/48G**

~~130,00€~~ **79,00€**

**MODULO 52 INSERTI DA 10MM**



**FG 100/51H**

**MODULO 7 CHIAVI MASCHIO ESAGONALI**

2, 5, 3, 4, 5, 6, 8mm

~~145,00€~~ **89,00€**



**FG 100/54**

**MODULO 5 UTENSILI DI MISURAZIONE**

~~170,00€~~ **99,00€**



**FG 100/56C**

**MODULO UTENSILI DA PERCUSSIONE**

FG 132/500, FG 136/40, FG 126/SN1, FG 126/SN3

~~135,00€~~ **79,90€**



**FG 100/55B**

**MODULO UTENSILI DA PERCUSSIONE**

FG 135/45 - FG 136-40

~~120,00€~~ **72,00€**



**FG 100/76C**

**MODULO TAPPI E CHIAVI FILTRI OLIO**

FG 176/F01 - FG 176/RE - FG 175/S15



~~274,00€~~ **165,00€**



**FG 100/VA1**

**MODULO VUOTO PORTA MINUTERIE**

~~24,00€~~ **14,50€**

**FG 106/A**
**CARRELLO PORTA ATTREZZI IN LAMIERA D'ACCIAIO**

- Dimensione: 350x750x957mm
- Lamiera d'acciaio 1.5mm
- Ruote montate su supporto rotante a piastra con gruppo rotante realizzato con doppia corona di sfere
- 2 ruote fisse, 1 girevole + 1 girevole con freno (Ø80mm)
- Peso totale: 19.5Kg

~~250,00€~~
**129,00€**

**FG 106/B**
**CARRELLO PORTA ATTREZZI IN LAMIERA D'ACCIAIO**

- Dimensione: 460x930x885mm
- Lamiera d'acciaio 1.5mm
- Ruote montate su supporto rotante a piastra con gruppo rotante realizzato con doppia corona di sfere
- 2 ruote fisse, 1 girevole + 1 girevole con freno (Ø100mm)
- Peso totale: 22.0Kg

~~300,00€~~
**159,00€**

**FG 106/C**
**CARRELLO PORTA ATTREZZI IN LAMIERA D'ACCIAIO  
- MOD. GIGANTE**

- Dimensione: 560x1.000x950mm
- Lamiera d'acciaio 2.0mm
- Ruote montate su supporto rotante a piastra con gruppo rotante realizzato con doppia corona di sfere
- 2 ruote fisse, 1 girevole + 1 girevole con freno (Ø125mm)
- Peso totale: 44.0Kg

~~390,00€~~
**199,00€**



# CARRELLI E BANCHI DA LAVORO

## GAMMA FG 128

### FG 128/2

#### BANCO DA LAVORO 2MT SENZA CASSETTI

Peso totale: 59,5Kg  
Portata statica: 2000Kg  
Dimensioni: 2.000x670x880mm

~~700,00€~~ **349,00€**

LAMIERA  
D'ACCIAIO  
DA 2mm



KG  
2000

MADE IN ITALY

PROFONDITA'  
670mm

DISPONIBILE CON DUE CASSETTI IN TRE VARIANTI COLORE

### FG 128/D2

#### BANCO DA LAVORO 2MT DOTATO DI 2 CASSETTI

Peso totale: 74,5Kg  
Portata statica: 2000Kg  
Dimensioni: 2.000x670x880mm

~~950,00€~~ **479,00€**



FG 128/D2

FG 128/B2

FG 128/R2

KG  
2000

MADE IN ITALY

## GAMMA FG 129

### FG 129/2

#### BANCO DA LAVORO 2MT SENZA CASSETTI

Peso totale: 77Kg  
Portata statica: 2000Kg  
Dimensioni: 2.000x745x880mm

~~850,00€~~ **449,00€**

LAMIERA  
D'ACCIAIO  
DA 3mm



KG  
2000

MADE IN ITALY

PROFONDITA'  
745mm

DISPONIBILE CON DUE CASSETTI IN TRE VARIANTI COLORE

### FG 129/D2

#### BANCO DA LAVORO 2MT DOTATO DI 2 CASSETTI

Peso totale: 92Kg  
Portata statica: 2000Kg  
Dimensioni: 2.000x745x880mm

~~1.100,00€~~ **579,00€**



FG 129/D2

FG 129/B2

FG 129/R2

KG  
2000

MADE IN ITALY

**FG 129/1**
~~550,00€~~ **289,00€**
**BANCO DA LAVORO 1MT**

Ripiano superiore in lamiera d'acciaio zincato da 3mm  
 Ripiano inferiore in lamiera d'acciaio fornita di serie  
 2 montanti  
 Predisposizione per fissaggio a pavimento  
 Struttura verniciata con vernice epossidica

Peso totale: 58Kg  
 Portata statica: 2000Kg  
 Dimensioni: **1.000x745x880mm**

 PROFONDITA'  
745mm

**MADE IN ITALY**
**FG 129/D1**
~~620,00€~~ **359,00€**
**BANCO DA LAVORO 1MT DOTATO DI 1 CASSETTO**

Ripiano superiore in lamiera d'acciaio zincato da 3mm  
 Ripiano inferiore in lamiera d'acciaio fornita di serie  
 2 montanti  
 Predisposizione per fissaggio a pavimento  
 Struttura verniciata con vernice epossidica

Peso totale: 64,5Kg  
 Portata statica: 2000Kg  
 Dimensioni: **1.000x745x880mm**

**FG 129/D1**
**FG 129/B1**
**FG 129/R1**

 PROFONDITA'  
745mm

**MADE IN ITALY**
**FG 129/1.5**
~~650,00€~~ **339,00€**
**BANCO DA LAVORO 1.5MT**

Ripiano superiore in lamiera d'acciaio zincato da 3mm  
 Ripiano inferiore in lamiera d'acciaio fornita di serie  
 2 montanti  
 Predisposizione per fissaggio a pavimento  
 Struttura verniciata con vernice epossidica

Peso totale: 77Kg  
 Portata statica: 2000Kg  
 Dimensioni: **1.500x745x880mm**

 PROFONDITA'  
745mm

**MADE IN ITALY**
**FG 129/D1.5**
~~720,00€~~ **419,00€**

Ripiano superiore in lamiera d'acciaio zincato da 3mm  
 Ripiano inferiore in lamiera d'acciaio fornita di serie  
 2 montanti  
 Predisposizione per fissaggio a pavimento  
 Struttura verniciata con vernice epossidica

Peso totale: 83,5Kg  
 Portata statica: 2000Kg  
 Dimensioni: **1.500x745x880mm**

**FG 129/D1.5**
**FG 129/B1.5**
**FG 129/R1.5**

 PROFONDITA'  
745mm

**MADE IN ITALY**



# CARRELLI E BANCHI DA LAVORO

**FG 129/D1-R**

~~815,00€~~ **399,00€**

**NEW**

KG  
2000

## BANCO DA LAVORO 1MT DOTATO DI 1 CASSETTO E RUOTE GIREVOLI

Ripiano superiore in lamiera d'acciaio zincato da 3mm  
Ripiano inferiore in lamiera d'acciaio fornita di serie  
2 montanti  
Predisposizione per fissaggio a pavimento  
Struttura verniciata con vernice epossidica  
Con 4 ruote girevoli (2 frenanti)

Peso totale: 69,5Kg

Portata statica: 2000Kg

Dimensioni: 1.000x745x880mm



**FG 129/D1-R**

**FG 129/B1-R**

**FG 129/R1-R**



**MADE IN ITALY**

**FG 129/D1.5-R**

~~915,00€~~ **459,00€**

KG  
2000

## BANCO DA LAVORO 1MT DOTATO DI 1 CASSETTO E RUOTE GIREVOLI

Ripiano superiore in lamiera d'acciaio zincato da 3mm  
Ripiano inferiore in lamiera d'acciaio fornita di serie  
2 montanti  
Predisposizione per fissaggio a pavimento  
Struttura verniciata con vernice epossidica  
Con 4 ruote girevoli (2 frenanti)

Peso totale: 88,5Kg

Portata statica: 2000Kg

Dimensioni: 1.500x745x880mm



**FG 129/D1.5-R**

**FG 129/B1.5-R**

**FG 129/R1.5-R**

**NEW**



**MADE IN ITALY**

**FG 129/D2-R**

~~1.270,00€~~ **639,00€**

KG  
2000

## BANCO DA LAVORO 2MT DOTATO DI 2 CASSETTI E RUOTE GIREVOLI

Ripiano superiore in lamiera d'acciaio zincato da 3mm  
Ripiano inferiore in lamiera d'acciaio fornita di serie  
3 montanti  
Predisposizione per fissaggio a pavimento  
Struttura verniciata con vernice epossidica  
Con 6 ruote girevoli (2 frenanti)

Peso totale: 97Kg

Portata statica: 2000Kg

Dimensioni: 2.000x745x880mm



**FG 129/D2-R**

**FG 129/B2-R**

**FG 129/R2-R**

**NEW**



**MADE IN ITALY**



**FG 137/D1.5**

**BANCO DA LAVORO 1.5MT  
CON VASCA DI RACCOLTA  
DI COLORE GRIGIO DARK  
E RUOTE GIREVOLI**

Peso totale: 90,00Kg  
Dimensione: 1.500x745x880mm

~~1.400,80€~~ **739,00€**

**MADE IN ITALY**

**RIPIANO MICRO FORATO**



**FG 137/R1.5**



**FG 137/B1.5**

**BANCO DA LAVORO CON 1 CASSETTIERA A 5 CASSETTI**



**FG 131/D2**

**BANCO DA LAVORO 2.0MT CON RIPIANO  
IN ACCIAIO E CASSETTIERA A 5 CASSETTI**

Peso totale: 121.50Kg  
Portata statica: 2.000Kg  
Dimensioni: 2.000x670x920mm

~~1.700,00€~~ **899,00€**

**MADE IN ITALY**



**FG 131/B2**



**FG 131/R2**



## Il meglio del made in Italy

RAL 6018

RAL 5002

RAL 3001

## Personalizza i tuoi spazi di lavoro!

I prodotti **Fasano Tools** sono frutto di un intenso lavoro di ricerca, sviluppo e progettazione interna. La vasta gamma di prodotti che proponiamo è caratterizzata da attenzione e cura per i dettagli, ma anche da stile e design.



MADE IN ITALY



**PRESE IN DOTAZIONE**  
PRESA 220V A 2 POLI  
+ 1 PRESA SHUKO A  
2 POLI + USB



**MODULO DISTRIBUZIONE**  
OLIO, DOTATO DI  
2 PISTOLE DIGITALI  
CONTA LITRI

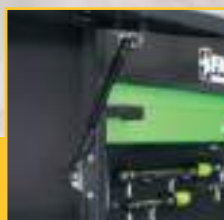

**PENSILI DOTATI DI**  
PISTONI A GAS  
PER AGEVOLARE  
L'APERTURA/CHIUSURA  
DELLA SPORTELLA



**VANO PORTA RIFIUTI**  
MONTATO SU GUIDE  
TELESCOPICHE

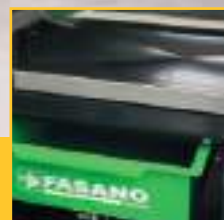

**PIANO DI LAVORO**  
IN ACCIAIO INOX  
E VASCA DI RACCOLTA  
ESTRAIBILE



**CASSETTI PREDISPOSTI**  
PER L'INSERIMENTO  
DEI MODULI COMPLETI  
DI UTENSILI

NEW

**FG 118/C014V**

**CONFIGURAZIONE DI ARREDAMENTO  
TECNICO DA 2.050MM**

CONFIGURAZIONE COMPOSTA DA:

- FG 118V/69A (Modulo armadietto a 2 antine)
- FG 118V/7T (Cassettiera mobile a 7 cassetti)
- FG 118V/40A (Modulo armadietto ad 1 antenna)
- 02 griglie porta utensili
- 02 prese di corrente composte da 1 presa 220V a 2 poli, 1 presa Schuko a 2 poli, USB

~~5.290,00€~~ **2.499,00€**



DIMENSIONI: 2.050X757X2.000mm

**MADE IN ITALY**



**FG 118/C014B**



**FG 118/C014R**

**FG 118/C02V**

**CONFIGURAZIONE DI ARREDAMENTO  
TECNICO DA 2.050MM**

CONFIGURAZIONE COMPOSTA DA:

- FG 118V/69A (Modulo armadietto a 2 antine)
- FG 118V/7T (Cassettiera mobile a 7 cassetti)
- FG 118V/40F (Modulo porta carta, dotato di cassetto porta rifiuti)
- 02 pensili superiori dotati di pistoni a gas e serratura di chiusura
- 02 griglie porta utensili
- 01 presa di corrente composta da 1 presa 220V a 2 poli, 1 presa Schuko a 2 poli, USB

~~5.840,00€~~ **2.999,00€**



DIMENSIONI: 2.050X757X2.000mm

**MADE IN ITALY**



**FG 118/C02B**



**FG 118/C02R**



## FG 118/C03V

### CONFIGURAZIONE DI ARREDAMENTO TECNICO DA 2.550MM

#### CONFIGURAZIONE COMPOSTA DA:

- FG 118V/69A (Modulo armadietto a 2 antine)
- FG 118V/7T (Cassettiera mobile a 7 cassetti)
- FG 118V/40F (Modulo porta carta, dotato di cassetto porta rifiuti)
- FG 118/AR1V (Armadietto laterale da 500mm)
- 02 pensili superiori dotati di pistoni a gas e serratura di chiusura
- 02 griglie porta utensili
- 01 presa di corrente composta da 1 presa 220V a 2 poli, 1 presa Schuko a 2 poli, USB

~~6.620,00€~~ **3.399,00€**

DIMENSIONI: 2.550X757X2.000mm

**MADE IN ITALY**



FG 118/C03B



FG 118/C03R



## FG 118/C08V

### CONFIGURAZIONE DI ARREDAMENTO TECNICO DA 1.220M DOTATA DI PENSILE SUPERIORE E GRIGLIA PORTA UTENSILI

#### CONFIGURAZIONE COMPOSTA DA:

- FG 118/69V7 (Cassettiera fissa a 7 cassetti)
- FG 118M/40F (Modulo porta carta, dotato di cassetto porta rifiuti)
- Pensile superiore dotato di pistoni a gas e serratura di chiusura
- 01 griglia porta utensili semplice
- 02 prese di corrente composte da 1 presa 220V a 2 poli, 1 presa Schuko a 2 poli cadauna, USB

~~3.770,00€~~ **1.999,00€**

DIMENSIONI: 1.225X757X2.000mm

**MADE IN ITALY**



FG 118/C08B



FG 118/C08R



**FG 118/C022V**

~~15.260,00€~~ **7.900,00€**

**CONFIGURAZIONE DI ARREDAMENTO  
TECNICO AD ANGOLO DA 7.160MM**

CONFIGURAZIONE COMPOSTA DA:

- FG 118/AR1V (Armadietto laterale da 500mm)
- FG 118V/69A (Modulo armadietto a 2 ante)
- FG 118V/7T (Cassettiera mobile a 7 cassetti)
- FG 118V/40F (Modulo porta carta, dotato di cassetto porta rifiuti)
- FG 118V/80AN: struttura angolare dotata di griglie porta utensili
- FG 118V/69E (Modulo porta rifiuti)
- FG 118M/40D (Modulo distribuzione aria compressa)
- FG 118/69V7 (Cassettiera fissa a 7 cassetti)
- FG 118/AR2V (Armadietto laterale a due ante)
- 04 pensili superiori dotati di pistoni a gas e serratura di chiusura
- 04 griglie porta utensili
- 02 prese di corrente composte ognuna da 1 presa 220V a 2 poli, 1 presa Schuko a 2 poli, 1 presa USB

**NEW**

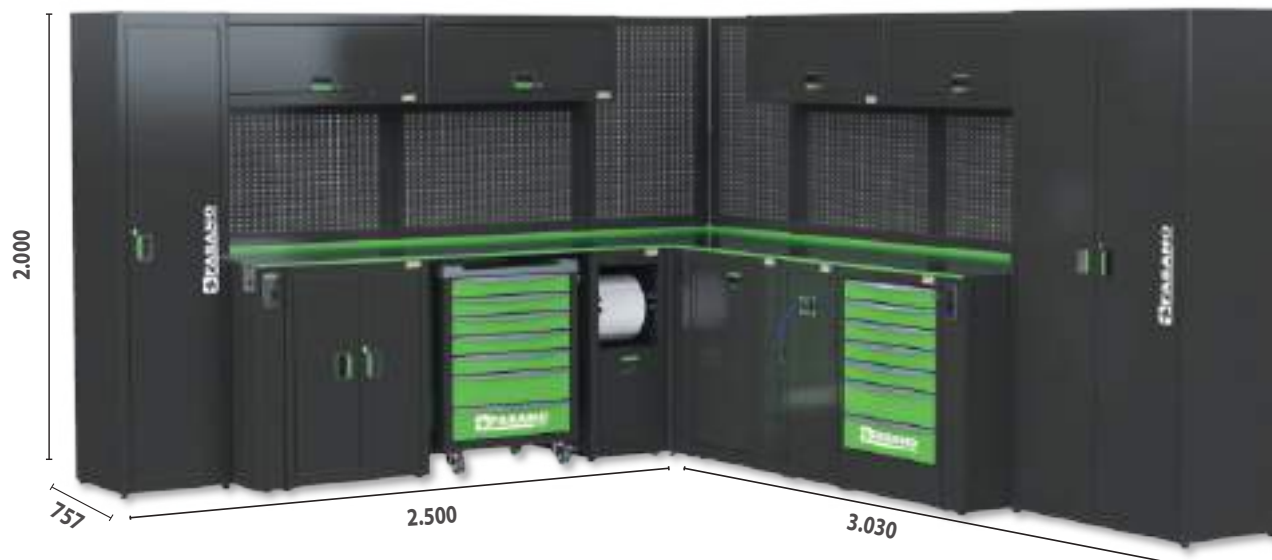
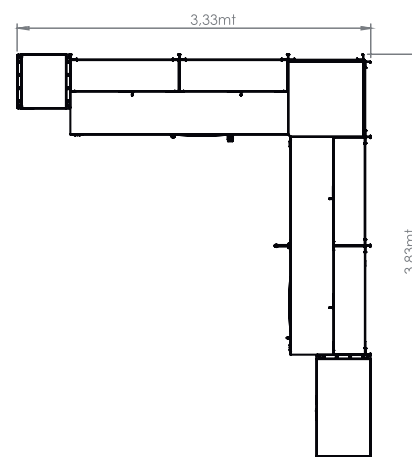

**FG 118/C022B**



**FG 118/C022R**



## MODULAR FORMS

## FG 116



RAL  
7021

RAL  
6018

**13 MODULI SINGOLI**  
per comporre la configurazione ideale  
per il tuo spazio di lavoro

### CARRELLI



### CASSETTIERE



### MODULI MULTIFUNZIONE





POSSIBILITA' DI INSERIRE MODULI DI  
UTENSILERIA ALL'INTERNO DEI CASSETTI



PIANO DI LAVORO IN ACCIAIO  
ZINCATO DA 2mm

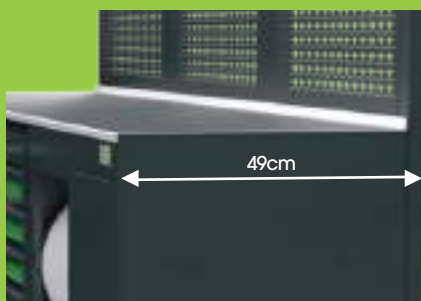

COMPOSIZIONE COMPATTA CON SOLO  
49cm DI PROFONDITA'



VANO PORTA RIFIUTI  
MONTATO SU GUIDE TELESCOPICHE



GRIGLIE PORTA UTENSILI

## NUOVO SISTEMA DI ARREDAMENTO TECNICO

per l'organizzazione e la personalizzazione  
del tuo spazio di lavoro

### COMPATTEZZA:

49 cm di profondità, ideale per arredare anche gli  
ambienti meno spaziosi

### ROBUSTEZZA:

Spessore del piano di lavoro in acciaio zincato: **2mm**  
Spessore struttura in lamiera zincata e verniciata: **1mm**

### QUALITÀ:

Struttura per griglie e pensili realizzata con colonne  
montata sugli stessi moduli per un'elevata resistenza nel  
tempo

### FUNZIONALITÀ:

Cassetti predisposti per l'inserimento dei moduli di utensili  
Fasano Tools

### MADE IN ITALY:

Progettato e realizzato in Italia all'interno dei nostri  
stabilimenti per garantire cura dei dettagli, stile elegante  
ed attenzione nella scelta dei materiali

### VERSATILITÀ:

Sistema flessibile e modulabile, con possibilità  
di completa personalizzazione oppure scelta di  
combinazioni predeterminate ampliabili o modificabili  
nel tempo.



## 4 TIPOLOGIE DI STRUTTURA BASE

MADE IN ITALY

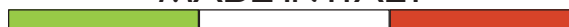

## CONFIGURAZIONI FG 116 DA 2.065mm



**FG 116/C02V**

~~4.305,00€~~ **2.149,00€**

CONFIGURAZIONE COMPOSTA DA:

- FG 116V/68A: Modulo armadietto
- FG 116V/7G: Carrello porta utensili
- FG 116V/68B: Armadietto, porta carta e porta rifiuti

## CONFIGURAZIONI FG 116 DA 2.065mm + ARMADIO



**FG 116/C03V**

~~5.025,00€~~ **2.599,00€**

CONFIGURAZIONE COMPOSTA DA:

- FG 116V/68A: Modulo armadietto
- FG 116V/7G: Carrello porta utensili
- FG 116V/68B: Armadietto, porta carta e porta rifiuti
- FG 118/AR1V: Armadio alto - 500x510x2.000mm

## CONFIGURAZIONI FG 116 DA 2.065mm



**FG 116/C06V**

~~4.355,00€~~ **2.199,00€**

CONFIGURAZIONE COMPOSTA DA:

- FG 116V/68A: Modulo armadietto
- FG 116/68V7: Cassettiera fissa a 7 cassetti
- FG 116V/68B: Armadietto, porta carta e porta rifiuti

## CONFIGURAZIONI FG 116 DA 1.375mm



**FG 116/C015V**

~~3.060,00€~~ **1.499,00€**

CONFIGURAZIONE COMPOSTA DA:

- FG 116/68V6: Cassettiera fissa a 6 cassetti
- FG 116V/68B: Armadietto, porta carta e porta rifiuti

**CONFIGURAZIONI FG 116 DA 2065mm + ARMADI**



**FG 116/C04V**

~~6.125,00€~~ **3.259,00€**

CONFIGURAZIONE COMPOSTA DA:

- FG 116V/68A: Modulo armadietto
- FG 116V/7G: Carrello porta utensili a 7 cassetti
- FG 116V/68B: Armadietto, porta carta e porta rifiuti
- FG 118/AR1V: Armadio alto - 2000x500x510mm
- FG 118/AR2V: Armadio alto - 2000x1000x510mm

**CONFIGURAZIONI FG 116 AD ANGOLO**



**FG 116/C030V**

~~8.070,00€~~ **3.999,00€**

CONFIGURAZIONE COMPOSTA DA:

- FG 116V/68B: Armadietto, porta carta e porta rifiuti
- FG 116V/7G: Carrello porta utensili a 7 cassetti
- FG 116V/68A: Modulo armadietto
- FG 116/68V6: Cassettiera fissa a 6 cassetti
- FG 116V/68A: Modulo armadietto

## Il lavoro on the road

### Arredamento furgoni!

Ai nostri clienti offriamo il massimo della qualità e dell'efficienza anche su strada.

L'allestimento **Fasano Tools** per furgoni e veicoli commerciali offre la possibilità di creare l'ambiente di lavoro ideale per le proprie esigenze.

Totalmente personalizzabile e modulare, si compone di cassettiere, armadietti, mensole, scaffali e pareti provviste di griglie portautensili, porta minuterie e una vasta gamma di accessori.

**Tutto il necessario per lavorare al di fuori della propria officina, seppur portandola sempre con sé.**

L'arredo tecnico Fasano Tools dedicato ai veicoli attrezzati si adegua perfettamente ad ogni necessità del lavoro quotidiano. Scegli il colore e la composizione ideale!

**MADE IN ITALY**

## Nuovi moduli in 3 varianti colore

RAL 6018

RAL 5002

RAL 3001



## MODULI

## ARREDAMENTO FURGONI



**MANIGLIE IN ABS CON IMPUGNATURA ERGONOMICA**



**CASSETTI CON APERTURA COMPLETA PER MODULI PORTA UTENSILI**

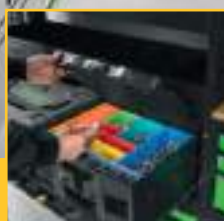

**VALIGIE COMPONENTI CON SCOMPARTI PORTA MINUTERIE**



**ANTE ESTRAIBILI AD APERTURA TOTALE**



**VASCHETTA IN PLASTICA PORTA MINUTERIE**

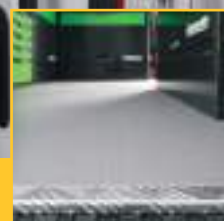

**PIANALI ANTISCIVOLO**





**FG 119V/C016**

~~2.400,00€~~ **1.199,00€**

**CONFIGURAZIONE ARREDAMENTO  
TECNICO PER FURGONI**

Dimensioni: 980x400x1.057mm

Peso: 61,8 Kg



**FG 119B/C016**



**FG 119R/C016**



**FG 119V/C025**

~~2.930,00€~~ **1.499,00€**

**CONFIGURAZIONE ARREDAMENTO  
TECNICO PER FURGONI**

Dimensioni: 1.225x400x1.057mm

Peso: 76,2 kg



**FG 119B/C025**



**FG 119R/C025**



**FG 119V/C012**

~~2.920,00€~~ **1.499,00€**

**CONFIGURAZIONE ARREDAMENTO  
TECNICO PER FURGONI**

Dimensioni: 980x400x1.592mm

Peso: 74,9 kg



**FG 119B/C012**



**FG 119R/C012**



**FG 119V/C022**

~~3.470,00€~~ **1.799,00€**

**CONFIGURAZIONE ARREDAMENTO  
TECNICO PER FURGONI**

Dimensioni: 1.225x400x1.592mm

Peso: 91,2 kg



**FG 119B/C022**



**FG 119R/C022**



**FG 119V/C033**

~~4.170,00€~~ **2.199,00€**

**CONFIGURAZIONE ARREDAMENTO  
TECNICO PER FURGONI**

Dimensioni: 1.470x400x1.360mm

Peso: 114 kg



**FG 119B/C033**



**FG 119R/C033**



**FG 119/BL**

**BANCO DA LAVORO**

Dimensioni piani: 810x250mm

Peso: 22,3Kg

~~850,00€~~ **439,00€**



**FG 119/PM**

**BANCO DA LAVORO DOTATO  
DI MORSA 125MM CON  
BASE GIREVOLE**

Dimensioni piano: 560x250mm

Peso: 40,5Kg

~~1.250,00€~~ **599,00€**



**FG 175/F074**

CHIAVE A TAZZA PER FILTRI OLIO FORD 1.0,2.0,2.3 ECOBOOST

~~45,50€~~ **26,90€**



3/8"

**FG 175/F074.5**

CHIAVE A TAZZA PER FILTRI OLIO FORD 1.5, 1.6 ECOBOOST

~~45,50€~~ **25,90€**



**FG 175/F074.5-8**

**NEW**

CHIAVE A TAZZA PER FILTRI OLIO FIAT, LANCIA, ALFA ROMEO

~~50,00€~~ **29,90€**



1/2"

**FG 175/F014M**

CHIAVE A TAZZA PER FILTRI OLIO MOTORI MERCEDES CDI

~~35,50€~~ **19,90€**



1/2"

**FG 175/F014T**

CHIAVE A TAZZA PER FILTRI OLIO MOTORI TOYOTA

~~30,00€~~ **17,90€**



1/2"

**FG 175/OP1**

CHIAVE FILTRO OLIO OPEL/VAUXHALL

~~46,50€~~ **27,90€**



1/2"

**FG 175/F084**

CHIAVE A TAZZA PER FILTRI OLIO MOTORI MERCEDES

~~57,00€~~ **33,90€**



1/2"

**FG 175/HI**

CHIAVE A TAZZA PER FILTRI OLIO MOTORE HYUNDAI TUCSON

~~67,00€~~ **39,90€**



1/2"



1/2"

**CHIAVE AUTOSERRANTE  
PER FILTRI OLIO PER SERRAGGI  
DESTROSI E SINISTRORSI  
- MODELLO PESANTE**

**NEW**

CODICE	Ø MM	LISTINO	€/PROMO
FG 178/UF110	80 - 110	115,00	69,00
FG 178/UF145	104-145	165,00	99,00

**FG 175/S15**



**SET 15 CHIAVI  
A BUSSOLA MAGNETICHE  
PER TAPPI OLIO**

~~135,00€~~ **79,00€**

**FG 175/S4**



**SET UTENSILI PER  
SMONTAGGIO TAPPI  
OLIO IN PLASTICA**

~~72,50€~~ **36,90€**

Adatto a:  
- VAG TFSI e TDI  
- FORD  
- BMW  
- CITROEN/PEUGEOT

**FG 175PF/S4**



**SET 4 CHIAVI A TAZZA  
PER FILTRI OLIO  
- MOD. PURFLUX**

~~74,50€~~ **44,90€**

**FG 175/S114**



**SET RIPARAZIONE  
TAPPI OLIO**

- M13x1.25 - M17x1.5  
- M13x1.5 - M20x1.5  
- M15x1.5 - M22x1.5

~~265,00€~~ **155,00€**

**FG 175/S30**



**SET 28 CHIAVI A TAZZA  
PER FILTRI OLIO**

~~221,50€~~ **125,00€**



21Pz

## FG 203/S20

**KIT PER IL CONTROLLO  
TENUTA DELL'IMPIANTO  
DI RAFFREDDAMENTO**

~~370,00€~~ **199,00€**



FG 203/BW1  
BMW



FG 203/F01  
FORD Fiesta dal  
2008



FG 203/OP1  
OPEL



FG 203/T01  
TOYOTA



FG 203/F02  
FORD

### TAPPI OPTIONAL

CODICE	LISTINO	€/PROMO
FG 203/BW1	36,50	21,90€
FG 203/F01	36,50	21,90€
FG 203/F02	36,50	21,90€
FG 203/OP1	36,50	21,90€
FG 203/T01	36,50	21,90€

## FG 203/A

**CHIAVE A BUSSOLA PER SMONTAGGIO  
TAPPI RADIATORE**



~~23,00€~~ **13,90€**

## FG 202/PV

**POMPA DI PRESSIONE  
E DEPRESSIONE**

~~230,00€~~ **135,00€**



## FG 203/S7



**STRUMENTO PER IL RIEMPIMENTO A DEPRESSIONE DEI  
CIRCUITI DI RAFFREDDAMENTO**

- Utile per effettuare uno spurgo  
perfetto grazie alla messa sotto  
vuoto del circuito di raffreddamento

~~166,00€~~ **99,00€**

## FG 176/S13

**POMPA PER  
INSERIMENTO OLIO  
CAMBI E DIFFERENZIALI**  
Capacità 7,5 litri



~~445,00€~~ **259,00€**

- Fornito di 12 accessori per connessione diretta
- Dotato di valvola di non ritorno

## FG 491/200

**SIRINGA PER OLIO E FLUIDI**

Fornita con 2  
guarnizioni di ricambio

~~38,00€~~ **22,90€**



200CC

## FG 491/1500

**SIRINGA PER OLIO**

Fornita con 2  
guarnizioni di ricambio

~~85,00€~~ **49,90€**



1.500CC

Non adatta per  
carburanti  
e olii minerali



**FG 191/S22**

~~620,00€~~ **369,00€**

**SET UNIVERSALE PER ESTRAZIONE ELETTRO-INIETTORI BOSCH, DELPHI, SIEMENS E DENSO**

- Completo di massa battente 4.8KG

CODICE	DESCRIZIONE	APPLICAZIONE
FG 191/ES-1	Adattatore M14X1.5	Delphi
FG 191/ES-2	Adattatore M16X1.5	
FG 191/ES-3	Adattatore M25X0.5	Denso
FG 191/ES-4	Adattatore M25X0.75	Denso
FG 191/ES-5	Adattatore M27X1.0	Bosch
FG 191/ES-6	Adattatore M16X1.0	Denso
FG 191/ES-7	Adattatore M17X1.0	Bosch
FG 191/ES-8	Adattatore M20X1.0	Denso
FG 191/ES-9	Adattatore M25X1.0	Siemens
FG 191/ES-10	Adattatore M27X1.0	Siemens
FG 191/ES-11	Estrattore a forchetta Ø 12 mm	Bosch
FG 191/ES-12	Estrattore a forchetta Ø 13.5 mm	Bosch
FG 191/ES-13	Estrattore a forchetta Ø 16 mm	
FG 191/ES-14	Estrattore a forchetta Ø 26 mm	
FG 191/ES-15	Giunto snodato	
FG 190/A25	Bussola rimozione connessione elettrica 25mm	Siemens
FG 190/A27	Bussola rimozione connessione elettrica 27mm	Siemens
FG 190/A29	Bussola rimozione connessione elettrica 29mm	Bosch
FG 190/A30	Bussola rimozione connessione elettrica 30mm	Bosch
FG 190/EL	Attrezzo rimozione elettrodo ø 7.5mm	
FG 190/EL1	Attrezzo rimozione elettrodo ø 6.9mm	

**FG 201/CR**

~~250,00€~~ **149,00€**

**SET PER VERIFICA ELETTRO-INIETTORI DIESEL COMMON RAIL**

Supporto a 6 burette

Adattato per Bosch, Siemens, Denso, e Delphi



**FG 190/AD1**

**ESTRATTORE A FORCHETTA PER INIETTORI PIEZO ELETTRICI**

~~52,00€~~ **29,90€**



**FG 190/AD2**

**ESTRATTORE LATERALE PER ELETTRO-INIETTORI BOSCH**

~~34,00€~~ **19,90€**

Per le masse battenti da associare ai codici FG 190/AD e FG 190/AD2 consultare il Catalogo generale a pagina 175

**FG 190/RI**

**ESTRATTORE PER RONDELLE INIETTORI**

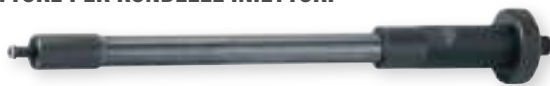

~~56,00€~~ **33,90€**

**FG 190/OP**



**ESTRATTORE INIETTORI OPEL MOTORI BENZINA AD INIEZIONE DIRETTA**

~~45,00€~~ **26,90€**

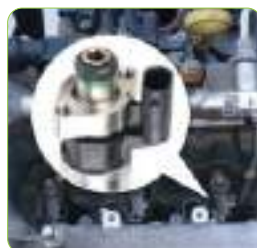

**FG 190/RE**

**ESTRATTORE INIETTORI DIESEL M9R - RENAULT/OPEL/NISSAN**



~~235,00€~~ **139,00€**

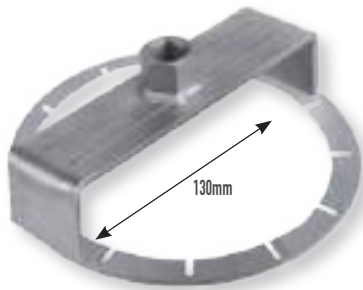

**FG 174/F2**~~72,50€~~ **43,50€****CHIAVE REGOLABILE PER  
GHIERE GALLEGGIANTI  
SERBATOIO CARBURANTE  
GRUPPO FCA****FG 174/SC**~~118,50€~~ **72,90€****CHIAVE PER  
GHIERE GALLEGGIANTI  
SERBATOIO CARBURANTE**  
Ømm88-170**FG 190/S21**~~350,00€~~ **209,00€****ASSORTIMENTO 21 UTENSILI E ALESATORI  
PER PULIZIA SEDI INIETTORI E CANDELETTE**  
In valigetta ABS

Codice	Descrizione
FG 190/S21-1	1- Asta porta frese dotato di molla per regolare la profondità
FG 190/S21-4	2- Serie 3 adattatori conici per imbocco sede iniettore (per asta porta frese)
FG 190/S21-5	3- Prolunga flessibile a innesto rapido con attacco quadro femmina 1/4"
FG 190/S21-6	4- Porta spazzole corto con attacco quadro maschio 1/4"
FG 190/S21-7	5- Spazzola lunga per la pulizia della sede iniettore
FG 190/S21-8	6- Set 6 tappi chiusura sede iniettore
FG 190/S21-9	7- Asta per l'inserimento dei tappi chiusura sede iniettore
FG 139/B2.5	8- Chiavino esagonale a L (2.5 mm)
FG 139/B3	9- Chiavino esagonale a L (3 mm)
FG 190/S21-11	10- Mandrino per fresa Ø 19 mm
FG 190/S21-12	11- Spazzola con setole in nylon per pulizia sede iniettore
FG 190/S21-13	12- Spazzola corta per la pulizia della camera iniettore
FG 190/RI	13- Estrattore per rondella di tenuta in rame
FG 190/S21-15	14- Alesatore Ø 15,5 mm

**FG 191/S14**~~150,00€~~ **89,00€****KIT PER PULIZIA SEDI INIETTORI**  
In valigetta ABS

Codice	Descrizione
FG 191/S14-2	1- Asta filettata M5X0.8XL200mm
FG 191/S14-3	2- Tappo chiusura sede iniettore
FG 191/S14-4	3- Spazzola lunga per la pulizia della sede iniettore
FG 191/S14-1	4- Prolunga flessibile
FG 191/S14-6	5- Spazzola a tazza Ø 15
FG 191/S14-7	6- Spazzola a tazza Ø 20
FG 191/S14-8	7- Spazzola Ø 24x85L
FG 191/S14-9	8- Spazzola Ø 18x85L
FG 191/S14-10	9- Spazzola Ø 21x85L

**FG 190/S6B**

~~165,00€~~ **99,00€**



**SET PER FRESATURA  
SEDI INIETTORI**

Codice	Descrizione
FG 190/S6-1	1- Fresa piana 17x17mm
FG 190/S6-2	2- Fresa piana 15x19mm
FG 190/S6-3	3- Fresa piana 17x19mm
FG 190/S6-4	4- Fresa conica 17x21mm
FG 190/S6-5	5- Fresa conica 17x17mm



**FG 182/S16**

~~500,00€~~ **299,00€**

**SET ESTRAZIONE CANDELETTE SPEZZATE  
M8, M10, MULTIJET**



Codice	Descrizione
FG 72/GMC3	1- Giraschi a cricchetto reversibile - mod. lungo
FG 182/S16-ES	2- Estrattore
FG 182/S16-PR	3- Prolunga doppia punta
FG 182/S16-PU10	4- Punta 7x4.2mm per FIAT Multijet
FG 182/S16-PR2	5- Prolunga per punta FIAT Multijet per 7x4.2mm
FG 139/3	6- Chiavino esagonale ad L 3 mm
FG 182/S16-GU	7- Guida per forare 6mm
FG 75/HSS3,5	8- Punta per forare 3.5 mm (2pz)
FG 182/S4-5	9- Inserto filettato M5
FG 182/S16/S4-4	10- Prolunga + maschio M5X0.8 (FIAT Multijet)
FG 182/S16/S4-3	11- Prolunga + maschio M8x1 (FIAT Multijet)
FG 182/S16-PU7	12- Punta per forare - 7x5.5mm
FG 182/S16-PU9	13- Punta per forare - 9x5.5mm
FG 72/GMC2	14- Giraschi a cricchetto reversibile - mod. corto
FG 182/S4-1	15- Estrattore
FG 182/S16-IF14	16- Inserto filettato 1/4" (2pz)
FG 624L/TX10	17- Chiave a bussola Torx E10
FG 72/M8X1	18- Serie 2 maschi a mano in acciaio HSS
FG 72/M10x1	19- Serie 2 maschi a mano in acciaio HSS
FG 182/S16-MA14	20- Maschio 1/4"

**FG 189/S13**

~~230,00€~~ **139,00€**

**SET CONTROLLO PRESSIONE SISTEMI TURBO**

Permette di verificare la tenuta dell'impianto di alimentazione dal collettore di spirazione fino alla chiocciola del compressore



**FG 179/S16**



**SET UTENSILI  
PER PULEGGE  
LIBERE ALTERNATORI**

~~160,00€~~ **89,00€**



FG 180/S38

~~700,00€~~ **399,00€**



**SET UTENSILI  
PER CENTRAGGIO  
FRIZIONI SAC**

FG 180/S17

~~590,00€~~ **199,00€**



**SET UTENSILI  
PER DIAGNOSI  
DOPPIE FRIZIONI DMF**

FG 178/SF

~~1.820,00€~~ **899,00€**



**APPARECCHIO SPURGO LIQUIDO FRENI**

- alimentazione 12V con cavi batteria
- dotato di vano posteriore porta oggetti e contenitore di recupero olio
- 2 tappi universali in dotazione

TAPPI IN DOTAZIONE



42mm

44,45,46mm

**PRESSIONE REGOLABILE  
FINO A 2 BAR**

**CAPACITÀ  
SERBATOIO 5L**

**SCocca IN  
ACCIAIO INOX**

**DOTATO DI SENSORE  
FINE LIQUIDO**

**TAPPI SPECIFICI PER MOTORI FORD (NON IN DOTAZIONE DI BASE)**



FG 178SF/AD13

Fiesta 2011-2016

~~60,00€~~ **35,90€**



FG 178SF/AD14

Mondeo dal 2014  
Fiesta dal 2016  
Mazda CX3/CX5

~~60,00€~~ **35,90€**

FG 178/S6

**KIT TAPPI  
PER VEICOLI ASIATICI**

- TOYOTA - MAZDA
- HYUNDAI - SUBARU
- NISSAN - HONDA
- MITSUBISHI - SUZUKI

~~330,00€~~ **179,00€**



FG 198/S11

**KIT SMONTAGGIO BULLONI PINZE FRENO**  
BMW, Ford, VAG, Mercedes



~~138,00€~~ **79,90€**

FG 198/B7

**CHIAVE A BUSSOLA PER  
BULLONI PINZE FRENO - 14MM**



~~17,50€~~ **9,90€**

FG 198/B9

**CHIAVE A BUSSOLA PER  
BULLONI PINZE FRENO - 9MM**



~~17,50€~~ **9,90€**

**FG 199/PF**



**SET ARRETRATORE PNEUMATICO PER PISTONCINI FRENI A DISCO**

Per destrorsi e sinistrorsi



~~225,00€~~ **135,00€**

**CHIAVE A BUSSOLA RINFORZATA PER DADI BULLONI RUOTA**

Attacco quadro interno: 1/2"

**NEW**



CODICE	MM	APPLICAZIONE	LISTINO	€/PROMO
FG 628/R17.5	16.5X17.5	FIAT, JEEP	20,00	11,90€
FG 628/R18.5	18.5X19.5	FORD	20,00	11,90€
FG 628/R21.5	21X21.5	FORD GALAXY, VOLVO, TOYOTA	22,00	11,90€
FG 628/R22.5	22X22.5	CHRYSLER DODGE, LAND ROVER, RANGE ROVER	22,00	11,90€
FG 628/R27.5	27X27.5	LAND ROVER DISCOVERY, RANGE ROVER	25,00	11,90€

1/2"

**FG 627/S3**

**CHIAVI A BUSSOLA PER CERCHI IN LEGA LEGGERA**

17, 19, 21mm



DOTATE DI ANELLO MAGNETICO DI TENUTA

~~85,00€~~ **44,90€**

**FG 628/S7**

~~115,00€~~ **69,00€**

**CHIAVI A BUSSOLA RINFORZATE PER CERCHI IN LEGA LEGGERA CON ADATTATORI PER BULLONI DANNEGGIATI**

17, 19, 21mm



1/2"

**KIT PER RIMOZIONE DADI ANTIFURTO**

**FG 164/S3**

~~250,00€~~ **145,00€**

**KIT RIMOZIONE DADI ANTI FURTO CON COLLARE - BMW**

Completo di massa battente e box in ABS



**FG 164/S10**

**SET CHIAVI A BUSSOLA PER RIMOZIONE DADI RUOTA ANTIFURTO UNIVERSALE**

Non utilizzare con avvitatori a percussione



~~180,50€~~ **109,00€**



FG 168/GA

~~60,00€~~ 36,00€



### UTENSILE DIVARICATORE UNIVERSALE

Elevata capacità  
Utilizzo universale  
Superfici di pressione parallele  
Capacità 5-11,5mm

NEW

FG 168/S7

~~250,00€~~ 149,00€

### ESTRATTORE A C PER BOCCOLE E CUSCINETTI

Struttura robusta con telaio in acciaio  
Con adattatori per attacco da 1/4", 3/8", 1/2", 3/4" per l'utilizzo su automobili, furgoni e veicoli commerciali  
Vite mm 165 - H/mm 89

NEW



FG 165/S26

~~700,00€~~ 429,00€

### SET UTENSILI SPECIALI PER SMONTAGGIO E MONTAGGIO SILENT BLOCK

Boccole per Ø 44-82mm  
4 barre filettate M10, M12, M14, M16



FG 165/S7

~~195,00€~~ 119,00€

### SET MONTAGGIO/SMONTAGGIO SILENT BLOCK FIAT PANDA 4X4 E PANDA METANO



FG 165/G01

~~180,00€~~ 99,00€

### ESTRATTORE PER GIUNTI OMOCINETICI



FG 166/S28

### KIT PER SMONTAGGIO E MONTAGGIO CUSCINETTI RUOTA

- smontaggio Ø 34-45mm  
- montaggio Ø 60-84mm



SMONTAGGIO



MONTAGGIO

FG 165/G02

### UTENSILE PER SMONTAGGIO GIUNTI OMOCINETICI



~~150,00€~~ 89,00€

~~475,00€~~ 279,00€



**FG 166/LT**

**AVVITATORE AD IMPULSI 18V  
(KIT CON 1 BATTERIA)**

~~750,00€~~ **399,00€**

**BRUSHLESS MOTOR**

18v - 5.0A

Scocca anteriore in acciaio resistente agli urti



Led di puntamento

Impugnatura Bi-material per un maggior grip

Aggancio rinforzato

Sistema di sgancio rapido

Batteria al Litio 5.0 Ampere e 18 Volt

Coppia massima

2.900



**FG 166/LT2**

**AVVITATORE AD IMPULSI 18V  
(KIT CON 2 BATTERIE)**

~~920,00€~~ **459,00€**



**FG 98/A1**

**CARICABATTERIE E MANTENITORE DI CARICA 6/12V**

- Corrente di carica 1A
- Capacità di carica 8Ah - 30Ah
- Utilizzabile con tutti i tipi di batterie, sia al piombo acido (WET, GEL, AGM, MF, EFB) che al litio
- Indicatore del livello di carica

**NEW**



~~65,00€~~ **39,00€**

**FG 98/A6**

**CARICABATTERIE E MANTENITORE DI CARICA 6/12V**

- Corrente di carica 6A
- Capacità di carica 8Ah - 100Ah
- Utilizzabile con tutti i tipi di batterie, sia al piombo acido (WET, GEL, AGM, MF, EFB) che al litio
- Display LCD
- 8 modalità di ricarica
- Indicatore del livello di carica
- Identificazione delle batterie esauste

**WINTER MODE**

CICLO DI RICARICA A BASSE TEMPERATURE

**NEW**



**FG 98/A15**

**CARICABATTERIE E MANTENITORE DI CARICA 6/12/24V**

- Corrente di carica massima 15 A (6V e 12V) - 8 A (24V)
- Capacità di carica 150Ah
- Utilizzabile con tutti i tipi di batterie, sia al piombo acido (WET, GEL, AGM, MF, EFB) che al litio
- 8 modalità di ricarica
- Indicatore del livello di carica
- Identificazione delle batterie esauste

**WINTER MODE**

CICLO DI RICARICA A BASSE TEMPERATURE

**JUMP MODE**

FUNZIONE RICARICA PER BATTERIE MOLTO SCARICHE

**NEW**



**FG 97/LT**

**AVVIATORE PORTATILE MULTIFUNZIONE**

- Adatto per l'avviamento di emergenza di motori con batteria da 12V
- Display LCD - 2 uscite USB 5V 2.4A
- Cavo 12V 10A per presa accendisigari in dotazione
- Led con 5 modalità
- 3 modalità di ricarica (in dotazione: caricabatterie, cavo USB tipo C, adattatore 14V 1A per presa accendisigari)
- Funzione Power Bank - Funzione Travel Lock
- In dotazione boost con morsetti per avviamento motore, custodia

~~250,00€~~ **149,00€**

**NEW**





**FG 172/FA2**

**NEW**

### PINZA A CRICCHETTO PER FASCETTE MANICOTTI

Funzione bloccaggio morsetti a cricchetto  
Apertura con meccanismo a molla



~~98,00€~~ **59,90€**

**FG 172/MA**

**NEW**

### PINZA PER FASCETTE A SCATTO CLIC

Con ganasce multipresa regolabili

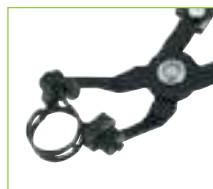

~~98,00€~~ **59,90€**

**FG 172/FA**

### PINZA PER FASCETTE A SCATTO CLIC



~~72,50€~~ **39,90€**

**FG 172/PA**

### PINZA PER SERRAGGIO E TAGLIO FASCETTE A NASTRO IN ACCIAIO INOX

Ø/MM 4.7 - 9.5

INDICATA ANCHE PER FASCETTE PANDUIT



~~67,00€~~ **39,90€**

**FG 172/AS2**



### PINZA PER ANELLI STRINGITUBO CON PROLUNGA INTERCambiabile

Apertura: 3-52mm

~~108,00€~~ **65,00€**

**FG 172/G02**

### PINZA PER COLLARI OETIKER

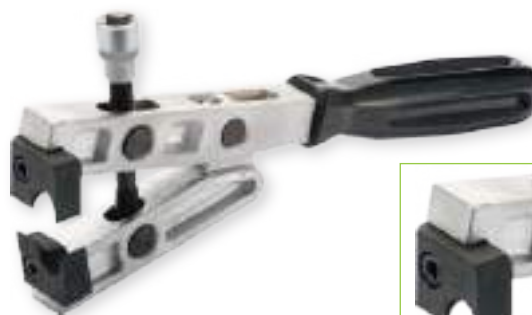

~~105,00€~~ **62,90€**

FG 184/S5



SET 5 CHIAVI PER DADI TENDICINGHIA

13, 15, 16, 17, 19mm

~~155,00€~~ **92,00€**

FG 184/S6

~~95,00€~~ **39,00€**

SET CHIAVE TENDICINGHIA CON INSERTI MASCHIO



CONTENUTO:

- TX40, TX45, TX60 - H8, H10

FG 184/FT1

~~70,00€~~ **39,00€**

CHIAVI PER DADI TENDICINGHIA FIAT, FORD, CITROEN, PEUGEOT



FG 181/PM2

ESTRATTORE UNIVERSALE  
PER PULEGGE



~~93,00€~~ **55,00€**

FG 172/TG

PINZA RIMOZIONE TUBI  
ACQUA E CARBURANTE



~~49,50€~~ **21,90€**

FG 172/MJ

PINZA RACCORDI  
RAPIDI TUBO CARBURANTE

Per Multijet



~~26,00€~~ **15,90€**

FG 172/S4

KIT UTENSILI PER SGANCIO  
RACCORDI FILTRI GASOLIO



~~50,00€~~ **19,90€**

FG 171/N

PINZA PER RACCORDI  
RAPIDI TUBO CARBURANTE



~~30,00€~~ **17,90€**

FG 171/FL

PINZA PER RACCORDI  
RAPIDI TUBO CARBURANTE  
CON TESTA FLESSIBILE



~~51,50€~~ **29,90€**



FG 215/S40

1.550,00€ 849,00€



TESTER PROVA COMPRESIONE DIGITALE, COMPLETO DI FINITI I NIETTORI E FINTE CANDELETTE PER SISTEMI DIESEL

MADE IN ITALY



ACCESSORI DI BASE IN DOTAZIONE

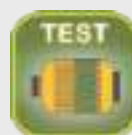

PROVA ALTERNATORE  
PROVA TENSIONE BATTERIA



PROVA COMPRESIONE

MADE IN ITALY



FG 219/S

3.350,00€ 1.999,00€



TESTER MULTI-FUNZIONE PER PROVA COMPRESIONE E PROVA PRESSIONE CARBURANTI

CARATTERISTICHE TECNICHE:

- grado di precisione: 1%FS
- software in 8 lingue (IT, EN, DE, FR, ES, PT, GR, PL)
- display touch screen LCD retroilluminato a colori, 4.3"
- 2 sensori (0-80Bar e 0.2500Bar)



PROVA ALTERNATORE  
PROVA TENSIONE BATTERIA



PROVA COMPRESIONE



PROVA PRESSIONE CARBURANTE  
(ALTA E BASSA)



PROVA OLIO MOTORE

**CE**
**FG 220/BT**
**TESTER DIGITALE PER BATTERIE 12V E 24V**
**CARATTERISTICHE TECNICHE:**

Dimensioni: 90X50X235 mm  
 Tensione di funzionamento: da 9V a 35V DC  
 Tempo di verifica della batteria: circa 1 minuto  
 Batteria interna per memoria data/ora: CR1220 (1 pezzo)

~~420,00€~~ **249,00€**

<b>CARATTERISTICHE:</b>	<b>DISPLAY RETROILLUMINATO</b>
	<b>SOFTWARE 6 LINGUE:</b> italiano; inglese; spagnolo; polacco; tedesco; francese
	<b>STAMPANTE INTEGRATA CON ROTOLO DI CARTA TERMICA</b>
	<b>SISTEMA RILEVAZIONE FALSO CONTATTO COLLEGAMENTO PINZE</b>
<b>APPLICAZIONI:</b>	<b>TEST BATTERIE 12 E 24V</b>
	<b>TEST ALTERNATORE (INTELLIGENTE E NORMALE) 12-24V CARICA</b>
	<b>TEST SISTEMA DI AVVIAMENTO</b>
<b>BATTERIE SUPPORTATE:</b>	<b>PB, WET, GEL AGM, AGM FLAT, EFB</b>
<b>APPLICAZIONI:</b>	<b>CCA: 100-1700; IEC: 100-1000; EN: 100-1700; DIN: 100-1000; JIS</b>
<b>LUNGHEZZA DEI CAVI:</b>	<b>570 mm</b>

**FG 193DSG/S9**



**SET MONTAGGIO, SMONTAGGIO E REGISTRAZIONE FRIZIONI DSG 7 RAPPORTI**

~~1050,00€~~ **599,00€**
**FG 193/DCT**

**UTENSILE INSERIMENTO E RIMOZIONE GRUPPO FRIZIONE DCT**

~~160,00€~~ **95,00€**
**FG 193/ATJ**

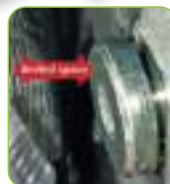
**UTENSILE SMONTAGGIO TAPPO OLIO CAMBIO JAGUAR/LAND ROVER**

~~45,00€~~ **26,90€**
**FG 194/TS**

**LEVA PER BLOCCAGGIO SBLOCCAGGIO GRUPPO MECCATRONICO FRIZIONE CAMBIO AUTOMATICO DSG**

~~32,00€~~ **19,00€**
**FG 193/MB**

**UTENSILE PER SCARICO E MISURAZIONE OLIO CAMBIO MERCEDES 9G TRONIC**

~~65,00€~~ **39,00€**



## Gli strumenti migliori, per veri professionisti

La gamma prodotti Fasano Tools dedicata al settore Carrozzeria comprende tutto il necessario per un lavoro altamente professionale.

**Utensili performanti e caratterizzati da dettagli votati all'efficienza.**

Il nostro vasto e completo assortimento di utensili per carrozzeria è dedicato a lavori di precisione e comprende kit di punzoni, set di raschietti, leve, coltelli, guidafile, impugnature, cunei, levapioli, pinze, leverini, levamolle, ventose, utensili dedicati alla rimozione di scegge ed ogni strumento essenziale per i professionisti del settore.

Scopri tutti  
nella sezione  
**AUTOMOTIVE**



VENTOLA DOTATA  
DI IMPUGNATURA  
E SISTEMA  
POMPANTE

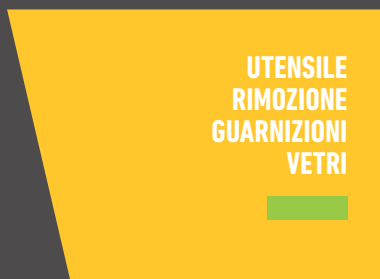

UTENSILE  
RIMOZIONE  
GUARNIZIONI  
VETRI



UTENSILE  
RIMOZIONE  
SCHEGGE



KIT 4  
MINI-VENTOSE  
PER CRISTALLI  
AUTO



RASCHIETTO  
MANUALE  
A LAMA  
DRITTA



KIT 6  
VENTOSE  
SINGOLE



**FG 130AL/S5**



**KIT PUNZONI IN PLASTICA E BULINO IN ALLUMINIO**

**Contenuto:**

1 bulino in alluminio regolabile 70mm-100mm

Filettatura M8x1.25

4 punzoni in gomma dura resistente agli urti e anti graffio

~~36,50€~~ **21,90€**



**FG 186/S11**

**SET 11 UTENSILI IN NYLON PER CARROZZERIA**

~~118,50€~~ **65,00€**



**FG 184P/S3**

~~26,00€~~ **14,90€**



**SET 3 CUNEI IN PLASTICA**

Materiale: Polipropilene ad alta resistenza

**FG 184R/S3**

~~46,50€~~ **27,90€**



**SET 3 RASCHIETTI IN ACCIAIO CON MANICO IN ABS**

Lunghezza totale: 280mm

**FG 184/R1**

~~21,00€~~ **12,50€**



**RASCHIETTO IN ACCIAIO CON MANICO IN ABS**

Lunghezza totale: 280mm

**FG 184/R2**

~~23,00€~~ **13,90€**



**RASCHIETTO IN ACCIAIO CON PROTEZIONE IN PVC E MANICO IN ABS**

Lunghezza totale: 275mm

**FG 188P/S2**

~~41,50€~~ **24,90€**



**KIT CUNEI PER RIMOZIONE MODANATURE IN PLASTICA**

Materiale: Polipropilene ad alta resistenza

1pz dotato di manico resistente alle percussioni

1pz senza manico per ideale per spazi ristretti



## FG 188/P1



### LEVA PER PARTI IN PLASTICA

MATERIALE: Nylon e fibra di vetro  
Elevata resistenza alla torsione  
Dotate di foro per appendimento



~~19,00€~~ **11,50€**

## FG 185P/S4



### KIT 4 LEVE PER PARTI IN PLASTICA

MATERIALE: Nylon e fibra di vetro  
Elevata resistenza alla torsione  
Dotate di foro per appendimento

~~26,00€~~ **15,90€**

## FG 186/S3

### SET 3 LEVERINI IN MATERIALE PLASTICO

~~10,00€~~ **5,90€**

## FG 186/S3B

### SET 3 UNCINI IN MATERIALE PLASTICO

~~12,00€~~ **6,90€**

## FG 186P/S5

### SET 5 LEVE IN NYLON RIMOZIONE PIOLI

~~37,50€~~ **19,90€**

## FG 185/S5

~~98,00€~~ **59,00€**

### SET 5 LEVAPIOLI CON MANICO IN ABS

Contenuto: FG 185/A1, FG 185/A2, FG 185/A6, FG 185/A7, FG 185/A8



## FG 186/AL1

**NEW**



### LEVA EXTRA PIATTA IN METALLO

Design unico della lama con un lato curvo ed uno dritto per la rimozione di elementi di fissaggio interni ed esterni anche negli spazi più stretti  
Punta sottile ad alta resistenza

~~25,00€~~ **14,90€**



## FG 185B/S2

### SET 2 LEVAPIOLI CON MANICO IN ABS

~~41,50€~~ **24,90€**

## FG 186/S5

### SET 5 LEVE CON LAMA IN ACCIAIO INOX

~~98,00€~~ **57,90€**



**FG 186/S4**

**NEW**

**SET 4 UNCINI CON LAMA IN ACCIAIO**  
Con impugnatura bimeriale



~~25,00€~~ **14,90€**

**FG 185/RM**

**UTENSILE PER RIMOZIONE MANIGLIA  
POGGIA MANO - GRUPPO VAG**

Lunghezza totale: 255mm  
Impugnatura in ABS



~~31,00€~~ **18,90€**

**FG 185/CR**



**UTENSILE LEVA MOLLE A "C"**

Ideale per la rimozione delle molle a C presenti sulle manovelle alzavetro

~~10,50€~~ **5,90€**



**FG 189/P01**



**UTENSILE RIMOZIONE CILINDRETTO CHIUSURA PORTIERE  
- GRUPPO VAG**

~~21,00€~~ **12,90€**

**FG 189/P02**



**UTENSILE RIMOZIONE CILINDRETTO CHIUSURA PORTIERE  
- GRUPPO VAG**

**NEW**

~~40,00€~~ **23,90€**

**FG 183/RV1**

~~21,00€~~ **12,90€**



**UTENSILE RIMOZIONE  
GUARNIZIONI VETRI**

Lunghezza totale: 252mm  
Impugnatura in ABS



**UTENSILE RIMOZIONE SCHEGGE**



L/mm

Ideale per la pulizia del canale alzavetro  
Punta sferica per evitare danneggiamenti delle guide portiera

CODICE	L/mm	LISTINO	€/PROMO
FG 182/RG10	255mm	19,00	11,50
FG 182/RG24	320mm	26,00	15,50



**FG 183/CM**

**COLTELLO MANUALE DOTATO DI CAVO E SISTEMA FERMA CAVO**

Impugnatura e cavo rivestito in PVC  
Fornito con una lama da 25mm già montata



~~51,50€~~ **29,90€**

**FG 183/RA1**

**RASCHIETTO MANUALE A LAMA DRITTA**



-Fornito con una lama in dotazione  
-Impugnatura in ABS dotata di foro per appendamento  
-Dotato di protezione lama in ABS

~~26,00€~~ **15,90€**



## COLTELLO MANUALE DOTATO DI LAMA INTERCAMBIABILE



Fornito con una lama in dotazione  
Impugnatura con rivestimento in PVC  
Sistema di bloccaggio lama a vite

CODICE	L/mm	LISTINO	€/PROMO
FG 183/CK250	250mm	22,00	12,90
FG 183/CK450	450mm	33,00	19,90
FG 183/CK600	600mm	41,50	24,90

## FG 187/GR

~~29,00€~~ **16,90€**

## UTENSILE UNIVERSALE PER FISSAGGIO GUARNIZIONI



Dotato di 6 accessori  
Sistema guida a rullo  
Impugnatura in ABS

## FG 187/GU

### LEVA BLOCCAFILO



~~29,00€~~ **16,90€**

## FG 187/IM

### SET 2 IMPUGNATURE PER CAVO D'ACCIAIO



~~41,50€~~ **24,90€**

## FG 187/GU2

### GUIDAFILO A T CON IMPUGNATURA IN ABS



~~26,00€~~ **15,90€**

lunghezza  
50 m

## FG 187/W50

### BOBINA DI FILO IN ACCIAIO PER TAGLIO SIGILLANTE - sezione quadrata



~~35,50€~~ **19,90€**

## FG 187/WT22.5

lunghezza  
22,5 m

### BOBINA DI FILO IN ACCIAIO PER TAGLIO SIGILLANTE - sezione triangolare



~~26,00€~~ **15,90€**

## FG 187/NY

lunghezza  
50 m

### BOBINA DI FILO IN NYLON - sezione intrecciata



~~62,00€~~ **36,90€**

## FG 187/IW50

lunghezza  
50 m

### BOBINA DI FILO IN ACCIAIO PER TAGLIO SIGILLANTE - sezione intrecciata



~~31,00€~~ **18,90€**

## FG 187/S2

~~700,00€~~ **419,00€**

### SET PER SMONTAGGIO PARABREZZA CON SISTEMA VENTOSE A CRICCHETTO In valigetta di ABS



NEW

## FG 188P/S4

~~65,00€~~ **39,90€**

### SET PROTEZIONE CRUSCOTTO CON MANIGLIA



NEW

**FG 187/K10**

~~24,00€~~ **14,50€**

**KIT 4 MINI-VENTOSE PER CRISTALLI AUTO** - capacità 10Kg



**FG 187/S7**

~~216,50€~~ **125,00€**

**SET 7 UTENSILI PER CRISTALLI AUTO**



**FG 187/K130**

**VENTOSA SINGOLA MULTIFUNZIONE**

- capacità: 130Kg
- diametro: 254mm
- adatta per parabrezza autobus e mezzi pesanti
- fornita in box di ABS

~~288,50€~~ **169,00€**



**FG 187/K40**

**VENTOSA SINGOLA DOTATA DI IMPUGNATURA E SISTEMA POMPANTE**

- capacità: 40 kg
- diametro: 178mm - 7"

~~196,00€~~ **109,00€**



**FG 187/K/S6**

~~57,00€~~ **33,90€**

**KIT 6 VENTOSE SINGOLE**

- capacità: 10 Kg - diametro: 78mm - 3"



**FG 165/BC3**

~~65,00€~~ **39,00€**

**ESTRATTORE REGOLABILE PER BRACCI TERGICRISTALLO BMW**  
Ø/mm max: 37,5 - L/mm: 64



**NEW**

**FG 187/PN**

~~263,00€~~ **159,00€**



**TIRABOLLI PNEUMATICO, COMPLETO DI 3 VENTOSE**



**FG 165BC/S6**

~~230,00€~~ **139,00€**

**SET 6 ESTRATTORI PER BRACCI TERGICRISTALLO**

- 1: VW, Porsche;
- 2: Ford, Seat, Mercedes;
- 3: BMW, VW;
- 4: Audi A3-A4-A5-A6;
- 5: VW, Opel, Honda;
- 6: Audi Q7



**NEW**



## COLONNETTE DI SOSTEGNO



CE

CODICE	CAPACITA'	H - MIN/MAX	€/PZ	€/PROMO
FG 725/3T	3 TON	285-425MM	95,00	49,00
FG 725/6T	6 TON	390-605MM	160,00	85,00
FG 725/12T	12 TON	495-720MM	280,00	149,00

## FG 750/A

### CARRELLO MOVIMENTAZIONE VEICOLI

- Capacità 680Kg
- Sistema di sollevamento a pedale
- Dotato di 4 ruote girevoli

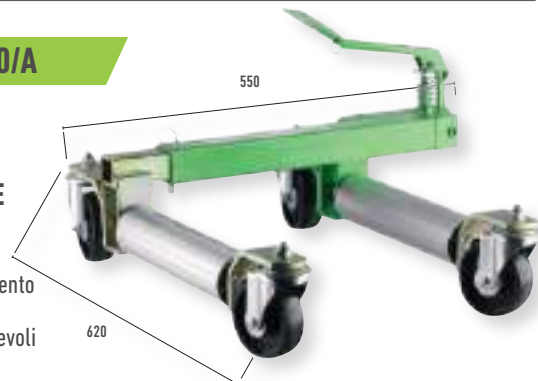

~~420,00€~~ **224,00€**

CE

### SOLLEVATORI IDRAULICI A BOTTIGLIA



CE

CODICE	CAPACITA'	H - MIN/MAX	STELO	€/PZ	€/PROMO
FG 735/4T	4 TON	193-373MM	60MM	85,00	45,00
FG 735/6T	6 TON	214-416MM	70MM	98,00	52,00
FG 735/10T	10 TON	230-460MM	80MM	140,00	74,00
FG 735/16T	16 TON	230-440MM	60MM	160,00	85,00
FG 735/20T	20 TON	242-452MM	60MM	200,00	105,00

## FG 748/0.5T

### SUPPORTO SOSTEGNO MOTORE

- Capacità 500Kg

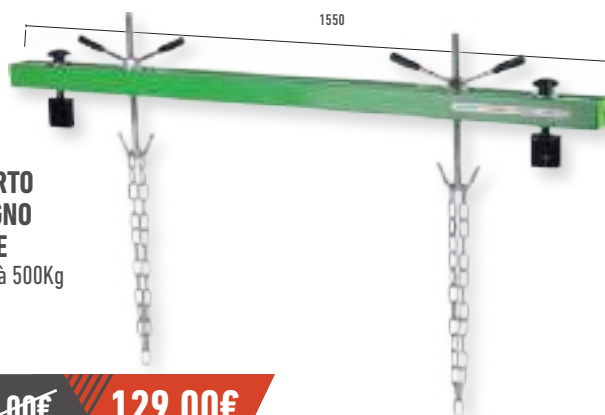

~~250,00€~~ **129,00€**

GUARDA IL VIDEO



**MADE IN ITALY**



**SICUREZZA TOTALE**  
Display digitale in grado di misurare la forza di compressione applicata



**AFFIDABILITA'**  
Le griffe sono dotate di un incavo profondo per garantire una presa totale della molla senza rischi di alcun genere per l'utilizzatore



**VELOCITA' D'USO**  
Lo speciale sistema autocentrante permette di posizionare i bracci con una sola mano e in modo rapido



**E' SICURO**  
E' dotato di base di appoggio inferiore per evitare cadute accidentali dell'ammortizzatore in fase di lavoro



**FG 750/1P**

**SMONTA AMMORTIZZATORI DOTATO DI 1 PISTONE**

Potenza spinta:  
1.2 ton (10 bar)  
- 0.9 ton (8 bar)  
Corsa di compressione molla: 300mm

~~2.600,00€~~ **1.389,00€**



**FG 750/2P**

**SMONTA AMMORTIZZATORI DOTATO DI 2 PISTONI**

Potenza spinta:  
2.4 ton (10 bar)  
- 1.9 ton (8 bar)  
Corsa di compressione molla: 300mm

~~3.300,00€~~ **1.699,00€**



**FG 752/1P**

**SMONTA AMMORTIZZATORI DOTATO DI 1 PISTONE E DISPLAY DIGITALE**

Il display digitale visualizza la pressione applicata durante la fase di utilizzo

~~3.400,00€~~ **1.699,00€**



**FG 752/2P**

**SMONTA AMMORTIZZATORI DOTATO DI 2 PISTONI E DISPLAY DIGITALE**

Il display digitale visualizza la pressione applicata durante la fase di utilizzo

~~4.100,00€~~ **1.999,00€**



**FG 213/LT**

**LEVA PER ESTRAZIONE TESTINE BRACCIO  
OSCILLANTE E AMMORTIZZATORI**



~~310,00€~~ **165,00€**

**FG 213/SM**

**TRAVERSA SOSTEGNO  
MOTORE INFERIORE**



~~750,00€~~ **399,00€**

**FG 740/0.5T**

~~600,00€~~ **319,00€**

**SOLLEVATORE IDRAULICO DA FOSSA E SOTTOPONTE  
- CAPACITÀ 500KG**

- Sistema di sollevamento a pedale
- Dotato di 4 ruote girevoli

CE



CE

**FG 738/1T**

~~1.100,00€~~ **579,00€**

**GRU IDRAULICA PIEGHEVOLE  
CON POMPA A DOPPIO EFFETTO**

- Capacità: 1 Ton
- Versione richiudibile
- Dotata di pompa a doppio effetto
- Ruote in acciaio per una maggiore durata e portata

**FG 745/CMR**

**CAVALLETTO SOSTEGNO MOTORE RICHIUDIBILE**

- Versione richiudibile
- Possibilità di rotazione a 360°
- Ruote in acciaio per una maggiore durata e portata

~~950,00€~~ **499,00€**



Sistema di rotazione a 360° a manovella



**FG 745/CMF**

**CAVALLETTO SOSTEGNO MOTORE**

- Possibilità di rotazione a 360°
- Ruote in acciaio per una maggiore durata e portata

~~460,00€~~ **245,00€**



Sistema di rotazione a 360°



**FG 710/C**

**SEGGIOLINO GIREVOLE, DOTATO DI ACCESSORI**

~~150,00€~~ **79,00€**



**FG 710/D**

**SEGGIOLINO GIREVOLE, DOTATO DI ACCESSORI**

~~245,00€~~ **129,00€**



**FG 710/E**

**NEW**



**LETTINO SOTTO MACCHINA IN PLASTICA ANTI-URTO**

Dimensioni: 1.000x470x130mm  
6 ruote girevoli

~~150,00€~~ **75,00€**

**FG 712/A**

**PORTA MINUTERIE/UTENSILI DOTATO DI RUOTE GIREVOLI**

- Dotato di 2 scomparti magnetici porta minuterie
- Dotato di 2 ampi scomparti porta utensili
- Dotato di piastra centrale magnetica
- 3 ruote girevoli da 500mm
- Materiale: ABS resistente agli urti



## FG 718/3.5T

### SOLLEVATORE IDRAULICO 3.5T MODELLO CORTO E RIBASSATO

#### CARATTERISTICHE TECNICHE:

- Design ribassato, ideale per lavorare su veicoli con bassa altezza da terra
- Portata elevata per utilizzo anche su fuoristrada e furgoni
- Robusta struttura in metallo
- Velocità di discesa controllata
- Manico con gomma antiurto
- 4 ruote in nylon
- Valvola di spurgo dell'aria
- Altezza minima 95 mm – altezza massima 540 mm
- Peso 39 kg

~~560,00€~~ **298,00€**



## DIMENSIONI

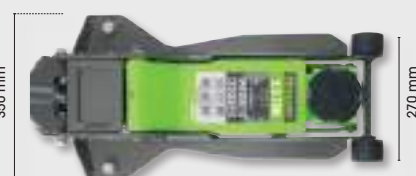
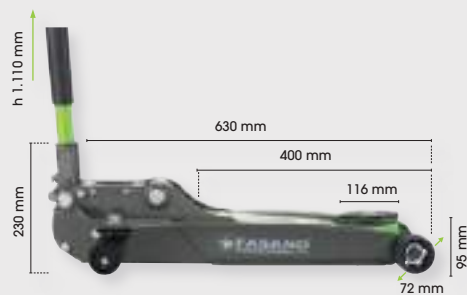

## FG 718/2.5T

### SOLLEVATORE IDRAULICO 2.5T MODELLO CORTO

#### CARATTERISTICHE TECNICHE:

- Robusta struttura in metallo
- Velocità di discesa controllata
- Manico con gomma antiurto
- 4 ruote in nylon
- Valvola di spurgo dell'aria
- Altezza minima 75 mm – altezza massima 510 mm
- Peso 30 kg

~~470,00€~~ **249,00€**

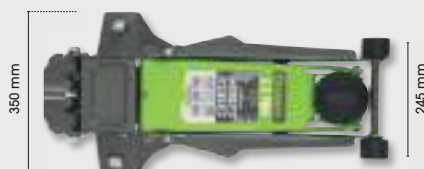
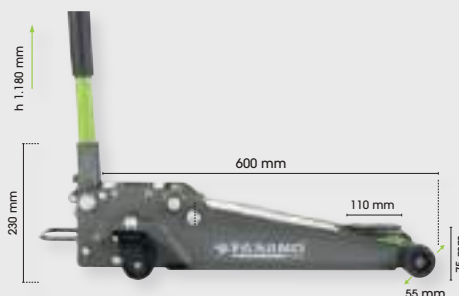

**DIMENSIONI**



**FG 719/2T**

**SOLLEVATORE IDRAULICO 2T  
MODELLO LUNGO E RIBASSATO**

**CARATTERISTICHE TECNICHE:**

- Design ribassato, ideale per lavorare anche su veicoli con bassa altezza da terra
- Versione lunga
- Robusta struttura in metallo
- Velocità di discesa controllata
- Manico con gomma antiurto
- 4 ruote in nylon
- Valvola di spurgo dell'aria
- Altezza minima 75 mm – altezza massima 610 mm
- Peso 43,5 kg

~~740,00€~~ **369,00€**



CE

**FG 722/5T**

**SOLLEVATORE IDRAULICO A CARRELLO 5 TON  
- MODELLO LUNGO PER MEZZI PESANTI**

~~1.420,00€~~ **755,00€**

Sistema di sollevamento ausiliario a pedale



Ruote in acciaio montate su cuscinetti a sfera

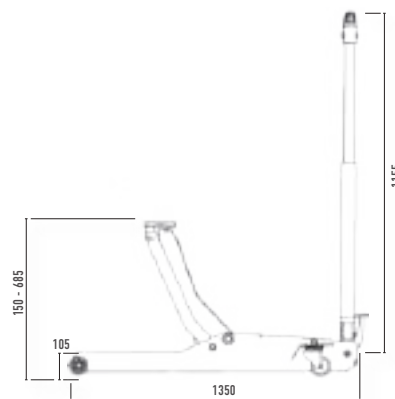

**SELF-RETURN INTEGRATO**



CE

CODICE	PAGINA	€/Promo
FG 22/S6	20	21,50
FG 22/S7	20	29,90
FG 22/S8	20	27,90
FG 22/S8B	20	31,90
FG 22/S10	20	37,90
FG 22/S12	20	53,90
FG 22TX/S6	21	38,90
FG 22E/S6	24	33,90
FG 22E/SZ6	24	33,90
FG 22TX/LS11	21	89,00
FG 44/MT3	30	6,90
FG 44/MT5	30	10,90
FG 44/MT8	30	13,90
FG 44/MT10	30	16,90
FG 47/S3	31	34,90
FG 47/S4	31	12,90
FG 49/TC	29	24,90
FG 49/TCX	29	28,90
FG 49/L	29	10,90
FG 49/MU	29	15,90
FG 50/ME	29	22,90
FG 50/PE	29	9,90
FG 51/S4	23	55,90
FG 51/S4B	23	61,90
FG 55/S4	23	76,00
FG 55/S4B	23	79,90
FG 56/S3	23	53,90
FG 57/S3	23	69,90
FG 58/A240	23	24,90
FG 58/B180	23	16,90
FG 58/B240	23	19,90
FG 58/B300	23	27,90
FG 59IS/S3	24	62,90
FG 59PV/S3	23	39,90
FG 59PV/S3B	23	44,90
FG 59XT/S3	23	49,90
FG 59XT/S3B	23	58,90
FG 67/350	29	29,00
FG 67/450	29	36,90
FG 67/600	29	49,90
FG 67/750	29	64,90
FG 68U/S439	24	169,00
FG 70/S110	28	199,00
FG 75CO/S25	28	139,00
FG 75TIN/S25	28	119,00
FG 77/PVC4	29	29,00
FG 79/SP3	33	3,30
FG 79/SP4	33	3,20
FG 80HSS/S3	28	89,00
FG 85/S100	22	59,00
FG 92/GR	31	14,90
FG 93/M50	33	17,90
FG 93/M95	33	17,90
FG 92/PM	31	11,50
FG 92/PF	31	13,90
FG 92/PM4	31	12,90
FG 94/MI	63	24,90
FG 94/MS	63	18,90
FG 94/R	63	11,90
FG 94/T	63	9,90
FG 95/CA	30	29,90
FG 95/CA2	30	69,00

CODICE	PAGINA	€/Promo
FG 95/CP1	30	59,00
FG 95/DG	30	55,00
FG 95/SP100	32	39,00
FG 96/DG	25	109,00
FG 97/DG	25	79,00
FG 98/DG	25	199,00
FG 99/DG	25	149,00
FG 96/SS30	32	29,90
FG 96/SS36	32	39,00
FG 96/SS60	32	36,00
FG 98/A1	119	39,00
FG 98/A6	119	69,00
FG 98/A15	119	169,00
FG 98/GAS	32	75,00
FG 97/LT	119	149,00
FG 98/LT	32	99,00
FG 100/03E	90	56,00
FG 100/03F	90	62,00
FG 100/03G	90	89,00
FG 100/03L	90	89,00
FG 100/03H	90	175,00
FG 100/07C	90	59,00
FG 100/07D	90	95,00
FG 100/08C	90	145,00
FG 100/10C	90	229,00
FG 100/10D	90	329,00
FG 100/17	90	79,00
FG 100/17E	90	169,00
FG 100/18	90	179,00
FG 100/19	90	139,00
FG 100/21B	91	145,00
FG 100/21C	91	145,00
FG 100/21D	91	99,00
FG 100/21H	91	259,00
FG 100/21M	91	99,00
FG 100/21TX	91	155,00
FG 100/23B	91	219,00
FG 100/23C	91	129,00
FG 100/39XT	91	62,90
FG 100/41C	91	65,00
FG 100/42C	91	69,00
FG 100/45D	92	39,00
FG 100/45E	92	49,00
FG 100/45H	92	49,00
FG 100/45I	92	49,00
FG 100/45T	92	52,00
FG 100/48G	92	79,00
FG 100/51H	92	89,00
FG 100/54	92	99,00
FG 100/55B	92	72,00
FG 100/56C	92	79,90
FG 100/65B	91	49,90
FG 100/65C	91	79,00
FG 100/76C	92	165,00
FG 100/81F	91	119,00
FG 100/VA1	92	14,50
FG 100B/5T	59	519,00
FG 100D/5T	59	519,00
FG 100R/5T	59	519,00
FG 100V/5T	59	519,00
FG 100W/5T	59	519,00
FG 100B/6T	59	539,00

CODICE	PAGINA	€/Promo
FG 100D/6T	59	539,00
FG 100R/6T	59	539,00
FG 100V/6T	59	539,00
FG 100W/6T	59	539,00
FG 100B/7T	59	559,00
FG 100D/7T	59	559,00
FG 100R/7T	59	559,00
FG 100V/7T	59	559,00
FG 100W/7T	59	559,00
FG 100BD/7T	59	699,00
FG 100BW/7T	59	699,00
FG 100BY/7T	59	699,00
FG 100CW/7T	59	699,00
FG 100DP/7T	59	699,00
FG 100DW/7T	59	699,00
FG 100GW/7T	59	699,00
FG 100MA/7T	59	699,00
FG 100RB/7T	59	699,00
FG 100RD/7T	59	699,00
FG 100RW/7T	59	699,00
FG 100RY/7T	59	699,00
FG 100VD/7T	59	699,00
FG 100VW/7T	59	699,00
FG 100V/AS212	69	1.099,00
FG 100B/AS212	69	1.099,00
FG 100R/AS212	69	1.099,00
FG 100D/AS212	69	1.099,00
FG 100W/AS212	69	1.099,00
FG 100V/AS183	70	1.149,00
FG 100B/AS183	70	1.149,00
FG 100R/AS183	70	1.149,00
FG 100D/AS183	70	1.149,00
FG 100W/AS183	70	1.149,00
FG 100V/AS371	71	1.399,00
FG 100B/AS371	71	1.399,00
FG 100R/AS371	71	1.399,00
FG 100D/AS371	71	1.399,00
FG 100W/AS371	71	1.399,00
FG 100VD/AS182	77	1.199,00
FG 100VW/AS182	77	1.199,00
FG 100BW/AS182	77	1.199,00
FG 100BD/AS182	77	1.199,00
FG 100RD/AS182	77	1.199,00
FG 100RY/AS182	77	1.199,00
FG 100CW/AS182	77	1.199,00
FG 100MA/AS182	77	1.199,00
FG 100RW/AS182	77	1.199,00
FG 100RB/AS182	77	1.199,00
FG 100DP/AS182	77	1.199,00
FG 100DW/AS182	77	1.199,00
FG 100BY/AS182	77	1.199,00
FG 100GW/AS182	77	1.199,00
FG 100V/AS224	78	1.199,00
FG 100B/AS224	78	1.199,00
FG 100R/AS224	78	1.199,00
FG 100D/AS224	78	1.199,00
FG 100W/AS224	78	1.199,00
FG 100VD/AS212	79	1.399,00
FG 100VW/AS212	79	1.399,00
FG 100BW/AS212	79	1.399,00
FG 100BD/AS212	79	1.399,00
FG 100RD/AS212	79	1.399,00

CODICE	PAGINA	€/Promo
FG 100RY/AS212	79	1.399,00
FG 100CW/AS212	79	1.399,00
FG 100MA/AS212	79	1.399,00
FG 100RW/AS212	79	1.399,00
FG 100RB/AS212	79	1.399,00
FG 100DP/AS212	79	1.399,00
FG 100DW/AS212	79	1.399,00
FG 100BY/AS212	79	1.399,00
FG 100GW/AS212	79	1.399,00
FG 100V/AS230	81	1.399,00
FG 100B/AS230	81	1.399,00
FG 100R/AS230	81	1.399,00
FG 100D/AS230	81	1.399,00
FG 100W/AS230	81	1.399,00
FG 100V/AS366	82	1.499,00
FG 100B/AS366	82	1.499,00
FG 100R/AS366	82	1.499,00
FG 100D/AS366	82	1.499,00
FG 100W/AS366	82	1.499,00
FG 100VD/AS355	83	1.599,00
FG 100VW/AS355	83	1.599,00
FG 100BW/AS355	83	1.599,00
FG 100BD/AS355	83	1.599,00
FG 100RD/AS355	83	1.599,00
FG 100RY/AS355	83	1.599,00
FG 100CW/AS355	83	1.599,00
FG 100MA/AS355	83	1.599,00
FG 100RW/AS355	83	1.599,00
FG 100RB/AS355	83	1.599,00
FG 100DP/AS355	83	1.599,00
FG 100DW/AS355	83	1.599,00
FG 100BY/AS355	83	1.599,00
FG 100GW/AS355	83	1.599,00
FG 100V/AS171	86	1.149,00
FG 100B/AS171	86	1.149,00
FG 100R/AS171	86	1.149,00
FG 100D/AS171	86	1.149,00
FG 100W/AS171	86	1.149,00
FG 100V/AS56	89	1.299,00
FG 100B/AS56	89	1.299,00
FG 100R/AS56	89	1.299,00
FG 100D/AS56	89	1.299,00
FG 100W/AS56	89	1.299,00
FG 101V/3G	62	249,00
FG 101V/5G	62	359,00
FG 101V/6G	62	379,00
FG 101V/7G	62	399,00
FG 101V/AS106	64	499,00
FG 101V/AS136	65	699,00
FG 101V/AS187	66	799,00
FG 102B/5G	60	469,00
FG 102D/5G	60	469,00
FG 102R/5G	60	469,00
FG 102V/5G	60	469,00
FG 102B/6G	60	499,00
FG 102D/6G	60	499,00
FG 102R/6G	60	499,00
FG 102V/6G	60	499,00
FG 102B/7G	60	529,00
FG 102D/7G	60	529,00
FG 102R/7G	60	529,00
FG 102V/7G	60	529,00

CODICE	PAGINA	€/Promo
FG 102B/8G	60	559,00
FG 102D/8G	60	559,00
FG 102R/8G	60	559,00
FG 102V/8G	60	559,00
FG 102/03G	72	85,00
FG 102/03L	72	89,00
FG 102/03H	72	149,00
FG 102/03E	72	49,00
FG 102/03F	72	59,00
FG 102/07C	72	59,00
FG 102/07D	72	79,00
FG 102/08C	72	145,00
FG 102/10C	72	199,00
FG 102/13C	72	109,00
FG 102/17	72	79,00
FG 102/17E	72	159,00
FG 102/19	73	119,00
FG 102/21B	73	139,00
FG 102/21C	73	139,00
FG 102/21D	73	99,00
FG 102/21E	73	99,00
FG 102/21H	73	119,00
FG 102/21R	73	135,00
FG 102/21TX	73	139,00
FG 102/23C	73	85,00
FG 102/25	73	239,00
FG 102/25B	73	239,00
FG 102/39XT	73	59,00
FG 102/39D	73	45,00
FG 102/41C	74	56,00
FG 102/42C	74	59,90
FG 102/45D	74	26,90
FG 102/45E	74	32,90
FG 102/45F	74	31,90
FG 102/45G	74	31,90
FG 102/45U	74	57,90
FG 102/45I	74	38,90
FG 102/45L	74	39,00
FG 102/45T	74	39,00
FG 102/48D	75	56,90
FG 102/48G	75	72,00
FG 102/50F	75	45,00
FG 102/50G	75	45,00
FG 102/51H	73	79,00
FG 102/56C	75	75,00
FG 102/62B	75	55,00
FG 102/60D	75	29,90
FG 102/65B	75	39,00
FG 102/VA1	75	8,90
FG 102V/AS158	67	999,00
FG 102B/AS158	67	999,00
FG 102R/AS158	67	999,00
FG 102D/AS158	67	999,00
FG 102V/AS168	68	1.099,00
FG 102B/AS168	68	1.099,00
FG 102R/AS168	68	1.099,00
FG 102D/AS168	68	1.099,00
FG 102V/AS183	76	999,00
FG 102B/AS183	76	999,00
FG 102D/AS183	76	999,00
FG 102R/AS183	76	999,00
FG 104B/6G	60	579,00

CODICE	PAGINA	€/Promo
FG 104D/6G	60	579,00
FG 104R/6G	60	579,00
FG 104V/6G	60	579,00
FG 104B/7G	60	599,00
FG 104D/7G	60	599,00
FG 104R/7G	60	599,00
FG 104V/7G	60	599,00
FG 104D/AS242	84	1.499,00
FG 104V/AS242	84	1.499,00
FG 104B/AS242	84	1.499,00
FG 104R/AS242	84	1.499,00
FG 104V/AS284	87	1.599,00
FG 104D/AS284	87	1.599,00
FG 104B/AS284	87	1.599,00
FG 104R/AS284	87	1.599,00
FG 105B/5G	61	689,00
FG 105D/5G	61	689,00
FG 105R/5G	61	689,00
FG 105V/5G	61	689,00
FG 105B/6G	61	739,00
FG 105D/6G	61	739,00
FG 105R/6G	61	739,00
FG 105V/6G	61	739,00
FG 105B/7G	61	769,00
FG 105D/7G	61	769,00
FG 105R/7G	61	769,00
FG 105V/7G	61	769,00
FG 106/A	93	129,00
FG 106/B	93	159,00
FG 106/C	93	199,00
FG 109D/6G	61	849,00
FG 109B/6G	61	849,00
FG 109R/6G	61	849,00
FG 109D/7G	61	879,00
FG 109B/7G	61	879,00
FG 109R/7G	61	879,00
FG 108/B	62	89,00
FG 109/L3	44	99,00
FG 111/A	45	32,90
FG 111/B	45	39,90
FG 111/C	45	49,90
FG 111/AS104	45	299,00
FG 113/A	45	99,00
FG 113/B	45	119,00
FG 113/C	45	149,00
FG 113/D	45	184,00
FG 114/L2	44	29,90
FG 114/L3	44	39,90
FG 116/A	46	199,00
FG 117/A	46	229,00
FG 116/CO2V	104	2.149,00
FG 116/CO3V	104	2.599,00
FG 116/CO4V	105	3.259,00
FG 116/CO6V	104	2.199,00
FG 116/CO15V	104	1.499,00
FG 116/CO30V	105	3.999,00
FG 118/AS56	47	429,00
FG 118/AS75	47	349,00
FG 118/CO2V	99	2.999,00
FG 118/CO2B	99	2.999,00
FG 118/CO2R	99	2.999,00
FG 118/CO3V	100	3.399,00

CODICE	PAGINA	€/Promo
FG 118/CO3B	100	3.399,00
FG 118/CO3R	100	3.399,00
FG 118/CO8V	100	1.999,00
FG 118/CO8B	100	1.999,00
FG 118/CO8R	100	1.999,00
FG 118/CO14V	99	2.499,00
FG 118/CO14B	99	2.499,00
FG 118/CO14R	99	2.499,00
FG 118/CO22V	101	7.900,00
FG 118/CO22B	101	7.900,00
FG 118/CO22R	101	7.900,00
FG 119B/CO12	108	1.499,00
FG 119R/CO12	108	1.499,00
FG 119V/CO12	108	1.499,00
FG 119B/CO16	108	1.199,00
FG 119R/CO16	108	1.199,00
FG 119V/CO16	108	1.199,00
FG 119B/CO22	109	1.799,00
FG 119R/CO22	109	1.799,00
FG 119V/CO22	109	1.799,00
FG 119B/CO25	108	1.499,00
FG 119R/CO25	108	1.499,00
FG 119V/CO25	108	1.499,00
FG 119B/CO33	109	2.199,00
FG 119R/CO33	109	2.199,00
FG 119V/CO33	109	2.199,00
FG 119/BL	109	439,00
FG 119/PM	109	599,00
FG 125/S3	33	39,90
FG 127/S1	31	28,90
FG 128C/S6	31	27,90
FG 128P/S6	31	24,90
FG 128/2	94	349,00
FG 128/B2	94	479,00
FG 128/D2	94	479,00
FG 128/R2	94	479,00
FG 129/1	95	289,00
FG 129/1.5	95	339,00
FG 129/2	94	449,00
FG 129/B1	95	359,00
FG 129/D1	95	359,00
FG 129/R1	95	359,00
FG 129/B1-R	96	399,00
FG 129/D1-R	96	399,00
FG 129/R1-R	96	399,00
FG 129/B1.5	95	419,00
FG 129/D1.5	95	419,00
FG 129/R1.5	95	419,00
FG 129/B1.5-R	96	459,00
FG 129/D1.5-R	96	459,00
FG 129/R1.5-R	96	459,00
FG 129/B2	94	579,00
FG 129/D2	94	579,00
FG 129/R2	94	579,00
FG 129/B2-R	96	639,00
FG 129/D2-R	96	639,00
FG 129/R2-R	96	639,00
FG 130AL/S5	125	21,90
FG 131/B2	97	899,00
FG 131/D2	97	899,00
FG 131/R2	97	899,00
FG 132/200	30	10,90

CODICE	PAGINA	€/Promo
FG 132/300	30	11,90
FG 132/500	30	12,90
FG 132/800	30	15,90
FG 132/1000	30	17,90
FG 137/B1.5	97	739,00
FG 137/D1.5	97	739,00
FG 137/R1.5	97	739,00
FG 138	22	29,90
FG 138/B	22	16,90
FG 138/BP	22	35,90
FG 138/C	22	19,90
FG 138/M	22	35,90
FG 139	21	21,90
FG 139C/FS	21	12,90
FG 139/B	21	9,90
FG 139/C	21	13,90
FG 139/LM	22	30,90
FG 139FS/IN	21	12,90
FG 139/IN	21	22,90
FG 139/L	21	23,90
FG 150H/S30	18	119,00
FG 150M/S26	18	109,00
FG 150TX/S32	18	119,00
FG 150R/AS167	80	1.299,00
FG 150D/AS167	80	1.299,00
FG 152RH/S9	19	69,00
FG 152RM/S9	19	69,00
FG 152/RTXS10	19	99,00
FG 160V/AS290	85	2.999,00
FG 160B/AS290	85	2.999,00
FG 160R/AS290	85	2.999,00
FG 160D/AS290	85	2.999,00
FG 160B/14L	63	1.889,00
FG 160D/14L	63	1.889,00
FG 160R/14L	63	1.889,00
FG 160V/14L	63	1.889,00
FG 160/1	49	65,00
FG 160/2	49	139,00
FG 160/3	49	249,00
FG 161/1	49	75,00
FG 161/2	49	149,00
FG 161/3	49	289,00
FG 162/S3	48	219,00
FG 162/FR1	48	89,90
FG 162/FR2	48	119,00
FG 162/FR3	48	139,00
FG 163/S2B	48	155,00
FG 164/S3	117	145,00
FG 164/S10	117	109,00
FG 165BC/S6	129	139,00
FG 165/BC3	129	39,00
FG 165/GO1	118	99,00
FG 165/GO2	118	89,00
FG 165/S7	118	119,00
FG 165/S26	118	429,00
FG 166/LT	119	399,00
FG 166/LT2	119	459,00
FG 166/S28	118	279,00
FG 168EP/S5	49	19,90
FG 168/S25	49	79,00
FG 168A/S5	49	65,00
FG 168A/S13	49	129,00

CODICE	PAGINA	€/Promo
FG 168/EF1	48	189,00
FG 168/EF2	48	199,00
FG 168/GA	118	36,00
FG 168/S7	118	149,00
FG 171/FL	121	29,90
FG 171/N	121	17,90
FG 172/AS2	120	65,00
FG 172/FA	120	39,90
FG 172/FA2	120	59,90
FG 172/GO2	120	62,90
FG 172/MA	120	59,90
FG 172/TG	121	21,90
FG 172/MJ	121	15,90
FG 172/S4	121	19,90
FG 172/PA	120	39,90
FG 174/F2	114	43,50
FG 174/SC	114	72,90
FG 175/FO14M	110	19,90
FG 175/FO14T	110	17,90
FG 175/FO74	110	26,90
FG 175/FO74.5	110	25,90
FG 175/FO74.5-8	110	29,90
FG 175/FO84	110	33,90
FG 175/HI	110	39,90
FG 175PF/S4	111	44,90
FG 175/S15	111	79,00
FG 175/S30	111	125,00
FG 175/S4	111	36,90
FG 175/S114	111	155,00
FG 175/OP1	110	27,90
FG 176/S13	112	259,00
<b>FG 178/SF</b>	<b>116</b>	<b>899,00</b>
FG 178SF/AD13	116	35,90
FG 178SF/AD14	116	35,90
FG 178/S6	116	179,00
FG 179/S16	115	89,00
FG 178/UF110	111	69,00
FG 178/UF145	111	99,00
FG 180/SP6	8	72,50
FG 180/SP9	8	125,00
FG 180/S17	116	199,00
FG 180/S38	116	399,00
FG 181/PM2	121	55,00
FG 182/S5B	49	279,00
FG 182/S14	49	145,00
FG 182/S16	115	299,00
FG 182/RG10	127	11,50
FG 182/RG24	127	15,50
FG 183/CM	127	29,90
FG 183/CK250	128	12,90
FG 183/CK450	128	19,90
FG 183/CK600	128	24,90
FG 183/RA1	127	15,90
FG 183/RV1	127	12,90
FG 184P/S3	125	14,90
FG 184/R1	125	12,50
FG 184/R2	125	13,90
FG 184R/S3	125	27,90
FG 184/FT1	121	39,00
FG 184/S5	121	92,00
FG 184/S6	121	39,00
FG 185/S5	126	59,00

CODICE	PAGINA	€/Promo
FG 185B/S2	126	24,90
FG 185/RM	127	18,90
FG 185/CR	127	5,90
FG 185P/S4	126	15,90
FG 186/AL1	126	14,90
FG 186/S4	127	14,90
FG 186/S5	126	57,90
FG 186P/S5	126	19,90
FG 186/S3	126	5,90
FG 186/S3B	126	6,90
FG 186/S11	125	65,00
FG 187/GU	128	16,90
FG 187/GU2	128	15,90
FG 187/IM	128	24,90
FG 187/IW50	128	18,90
FG 187/NY	128	36,90
FG 187/S2	128	419,00
FG 187/S7	129	125,00
FG 187/PN	129	159,00
FG 187/W50	128	19,90
FG 187/WT22.5	128	15,90
FG 187/K10	129	14,50
FG 187/K40	129	109,00
FG 187K/S6	129	33,90
FG 187/K130	129	169,00
FG 187/GR	128	16,90
FG 188/P1	126	11,50
FG 188P/S2	125	24,90
FG 188P/S4	128	39,90
FG 189/PO1	127	12,90
FG 189/PO2	127	23,90
FG 189/S13	115	139,00
FG 190/AD1	113	29,90
FG 190/AD2	113	19,90
FG 190/OP	113	26,90
FG 190/RE	113	139,00
FG 190/RI	113	33,90
FG 190/S6B	115	99,00
FG 190/S21	114	209,00
FG 191/S14	114	89,00
FG 191/S22	113	369,00
FG 193/ATJ	123	26,90
FG 193/MB	123	39,00
FG 193/DCT	123	95,00
FG 193DSG/S9	123	599,00
FG 194/TS	123	19,00
FG 198/S11	116	79,90
FG 198/B7	116	9,90
FG 198/B9	116	9,90
FG 199/PF	117	135,00
FG 201/CR	113	149,00
FG 202/PV	112	135,00
FG 203/A	112	13,90
FG 203/BW1	112	21,90
FG 203/FO1	112	21,90
FG 203/FO2	112	21,90
FG 203/OP1	112	21,90
FG 203/TO1	112	21,90
FG 203/S7	112	99,00
FG 203/S20	112	199,00
FG 202	35	32,90
FG 203	34	12,90

CODICE	PAGINA	€/Promo
FG 204	34	18,90
FG 205	34	49,90
FG 213/L480	35	39,90
FG 214/L600	38	39,00
FG 206	35	32,90
FG 207	35	35,90
FG 207/B	36	59,90
FG 208	36	119,00
FG 209	36	149,00
FG 210/A	36	49,90
FG 210/B	37	49,90
FG 210/C	38	99,00
FG 211	37	59,00
FG 217	38	149,00
FG 212	37	39,90
<b>FG 213/LT</b>	<b>132</b>	<b>165,00</b>
<b>FG 213/SM</b>	<b>132</b>	<b>399,00</b>
FG 215/S40	122	849,00
FG 219/S	122	1.999,00
FG 220/BT	123	249,00
FG 221	39	199,00
FG 222/A	35	69,00
FG 222/B	38	189,00
FG 224/L5200	39	149,00
FG 224/SU	39	59,00
<b>FG 225/SK1.5</b>	<b>41</b>	<b>149,00</b>
<b>FG 225/SK2.5</b>	<b>41</b>	<b>169,00</b>
FG 234	40	59,00
FG 235	40	79,00
FG 236	41	199,00
FG 236/SU	41	59,00
FG 490/C500	33	31,20
FG 490/C800	33	39,00
FG 491/200	112	22,90
FG 491/1500	112	49,90
FG 493/AL	33	26,90
FG 493/N	33	23,50
FG 494/S12	33	32,90
FG 531	26	125,00
FG 533/2	26	139,00
FG 536/1	26	139,00
FG 536/2	26	145,00
FG 536/3	26	159,00
FG 538/1	26	469,00
FG 538/2	26	529,00
FG 539/1	26	679,00
FG 540/1	26	629,00
FG 540/2	26	719,00
FG 543/DG1	26	389,00
FG 543/DG2	26	459,00
FG 546/DG	27	195,00
FG 547/DG	27	125,00
FG 544/1	26	119,00
FG 544/2	26	129,00
FG 544/3	26	139,00
FG 544/4	26	159,00
FG 559/1	27	125,00
FG 559/2	27	135,00
FG 580/A	27	99,00
FG 580/B	27	129,00
FG 600/SC17	8	99,00
FG 600/SC16	8	139,00

CODICE	PAGINA	€/Promo
FG 600/SC25	8	209,00
FG 600E/S4	10	32,00
FG 600L/SC10	8	89,00
FG 602/SC13	8	89,00
<b>FG 603/TA1</b>	<b>88</b>	<b>145,00</b>
FG 605/ST9-B	11	109,00
FG 605/ST11-B	11	129,00
FG 605/SC15	11	149,00
FG 605/SP6	11	65,00
FG 606/SP9	11	79,00
FG 609A/S5	10	59,00
FG 610FL/SP9	11	135,00
FG 614B/S13	9	99,00
FG 615/SC8	8	69,00
FG 615A/S6	10	75,00
FG 616A/S6	9	79,00
FG 617A/S7	10	75,00
FG 618/S7B	9	155,00
FG 618/S7	9	169,00
FG 618/S10	9	239,00
FG 618E/S9	9	249,00
FG 621H/S8C	10	89,00
FG 621TX/S13	10	129,00
FG 622A/S2	10	49,00
FG 624B/TXS10	13	49,00
FG 624/CR14	12	23,90
FG 624/FR14	12	24,90
FG 624/MCH	12	21,90
FG 624/MCR	12	21,90
FG 624/RT14	12	38,90
FG 624/S25	13	49,90
FG 624/S25A	13	49,90
FG 624/S29	13	129,00
FG 624/S45	13	129,00
<b>FG 624B/S80</b>	<b>14</b>	<b>99,00</b>
<b>FG 625/S27</b>	<b>14</b>	<b>99,00</b>
<b>FG 625/S74</b>	<b>16</b>	<b>129,00</b>
<b>FG 625/S94</b>	<b>16</b>	<b>149,00</b>
<b>FG 625/S110</b>	<b>17</b>	<b>249,00</b>
FG 625/CR12	12	31,90
FG 625/FR12	12	33,90
FG 625/RT12	12	49,90
FG 625TX/S13	14	69,00
FG 628/S12	19	79,00
FG 628/S6	19	55,00
FG 627/S3	117	44,90
FG 628/R17.5	117	11,90
FG 628/R18.5	117	11,90
FG 628/R21.5	117	11,90
FG 628/R22.5	117	11,90
FG 628/R27.5	117	11,90
FG 628/S7	117	69,00
FG 629A/S15	18	339,00
FG 629B/S15	18	339,00
FG 629C/S10	19	159,00
FG 630A/S14	19	499,00
<b>FG 710/C</b>	<b>133</b>	<b>79,00</b>
<b>FG 710/D</b>	<b>133</b>	<b>129,00</b>
<b>FG 710/E</b>	<b>134</b>	<b>75,00</b>
<b>FG 712/A</b>	<b>133</b>	<b>19,90</b>
FG 712/L4	31	49,00
<b>FG 718/2.5T</b>	<b>134</b>	<b>249,00</b>



# INSIEME CORRIAMO PIU' VELOCI!



**ED**  
MOTORSPORT

Durante le stagioni sportive 2022 e 2023, Fasano Tools ha affidato il ruolo di Brand Ambassador al giovane Sport Driver Eliseo Donno. L'elegantissima Ferrari 488 Evo ha portato, con onore, sui circuiti Internazionali più prestigiosi, il marchio Fasano Tools, Main Sponsor, simbolo di una partnership basata sulla reciproca fiducia e stima.

Nel 2023 Eliseo Donno è diventato Campione Europeo nel Campionato "Ferrari Challenge - Trofeo Pirelli" e ha conquistato il secondo posto sia nella competizione mondiale del medesimo campionato, che sul podio del Campionato Cult GT3.



**SLP**  
CORSE

Il nostro partner a due ruote per il 2023 è stato il team sportivo SLP Corse.

Impegnata da decenni nelle competizioni motociclistiche, in questa stagione sportiva SLP Corse ha svolto il ruolo di Brand Ambassador Fasano Tools nel Campionato Italiano Velocità, CIV National Trophy e le emozioni che ci ha regalato Alessandro Arcangeli, "il pilota matto della 1000", già Campione 2021 del Trofeo Aprilia RS660, sono state davvero tante. Competiamo per vincere, ma anche per crescere.

**DINAMIC GT**

Fasano Tools sceglie la squadra sportiva Dinamic GT, attiva dal 2019 in campionati monomarca, e ne diventa Sponsor nella stagione sportiva 2023.

Nel GT World Challenge Europe, il team ha festeggiato quattro vittorie assolute con la 911 GT3 R. Inoltre è stata attiva anche sulla Nordschleife e ha partecipato come ospite all' ADAC GT Masters nel 2022.

La Porsche Verde del team, ha "indossato" il logo Fasano e, con orgoglio, lo ha sfoggiato sui circuiti Internazionali Cult delle competizioni automobilistiche per accendere, a suon di rombo di motori, la fiamma verde della vittoria.



**BEFUEL**

D'ispirazione per tutti i professionisti del settore della meccanica, della carrozzeria e del mondo automotive, i nostri Partner di Be Fuel Performance lavorano ormai da anni utilizzando i carrelli Made in Italy customizzati e gli utensili Fasano Tools.

Non esiste sul web un progetto che sia uguale a loro. Ai ragazzi di Be Fuel modificare e personalizzare non basta quasi più. Le auto "bacciate" dal loro tocco diventano dei veri e propri prototipi da sfoggiare in piste e competizioni prestigiose, per superare ogni volta il limite imposto.

Nel 2023 ci hanno stupiti con incredibili makeover di vetture, contest e sfide creative, esplorando nuovi orizzonti del settore Automotive.





**FASANGAS S.r.l.**

Viale Grecia 3, lotto 18 Zona Industriale 73100  
LECCE (LE) ITALY (+39) 0832.362097/364265  
info@fasanotools.com

**FASANOTOOLS.COM**



**VALIDITA': 05-02-2024/02-02-2025**



8 053853 745354